

FADO[®] 43

Anos

LANÇAMENTOS



BAIXE O CATÁLOGO FADO



WHATSAPP COMERCIAL FADO

PEÇAS PARA IMPLEMENTOS RODOVIÁRIOS

CATÁLOGO 2024

ÍNDICE

RODOFORT	03
ESTRADA	09
RANDON	11
NOMA	14
LIBRELATO	15
DIVERSOS	16



CONHEÇA A FADO, FABRICANTE NACIONAL DE PEÇAS PARA CARRETAS E ESCAPAMENTOS

Qualidade como missão e filosofia, essa é a diretriz da Fado, fabricante nacional de escapamentos e acessórios automotivos e peças para implementos rodoviários. Produzindo também linha completa de suportes flexíveis, a Fado oferece soluções inteligentes e modernas para o transporte, indústria e construção civil.



A mais completa linha de escapamentos automotivos para caminhões do Brasil

Com mais de 40 anos de atuação e liderança no mercado em que atua, a Fado está instalada em São Marcos, capital gaúcha do caminhoneiro, com 8 mil m² de área construída, oferecendo a mais completa linha de escapamentos automotivos para transporte pesado no Brasil, atendendo o setor de reposição para todas as grandes montadoras de caminhões.



Qualidade e inovação para o setor de Implementos Rodoviários

A Fado trouxe ao setor de implementos rodoviários inovação, qualidade, comprometimento e fabricação de produtos personalizados, de acordo com o perfil de cada cliente. Em 2017 iniciou a linha de fabricação de peças para carretas, sempre focada na qualidade e filosofia da Fado, hoje contando com amplo mix de produtos, atendendo o setor de reposição das grandes montadoras.



Desenvolvimento de produto e logística internalizados

A Fado possui o setor de Pesquisa e Desenvolvimento de Produto internalizado, garantindo a manutenção de um alto padrão de exigência e qualidade em todas as etapas e agilidade no atendimento de novas necessidades de mercado. Também possui logística própria de distribuição, oferecendo segurança na entrega, desde a saída da fábrica até a chegada aos revendedores, em diferentes pontos do Brasil e América do Sul. Além disso, mantém seus processos em conformidade com os requisitos da NBR ISO 9001.

Confiança e
segurança nas
estradas pelo
mundo.

Qualidade reconhecida
internacionalmente

A Fado está presente na Argentina,
Brasil, Chile, Paraguai, Peru e Uruguai



ACESSE O SITE FADO.COM.BR



WHATSAPP COMERCIAL FADO

LINHA CARRETAS RODOFORT

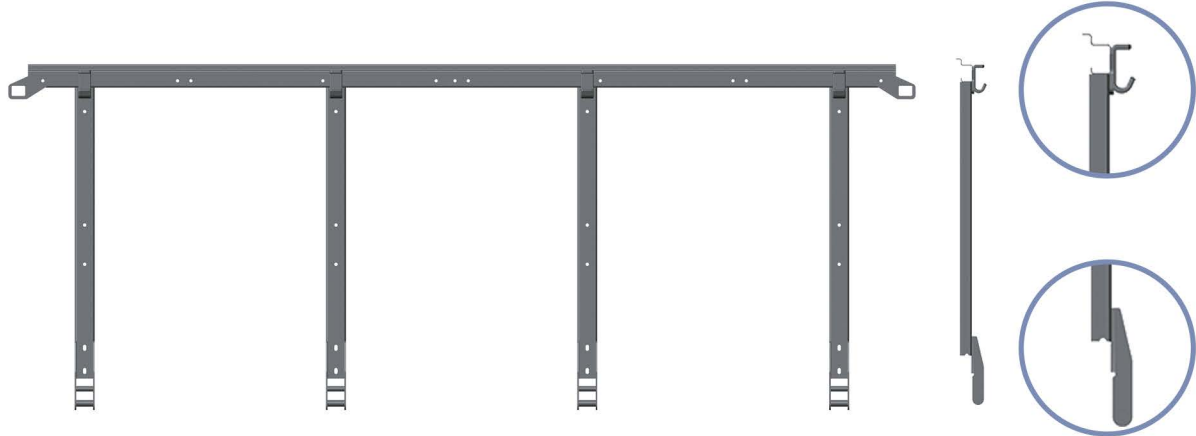

CÓDIGO	ALT.(MM)	LARG.(MM)
FD0007M	800	2212
FD0007S	1000	2212

GRADE LATERAL INFERIOR

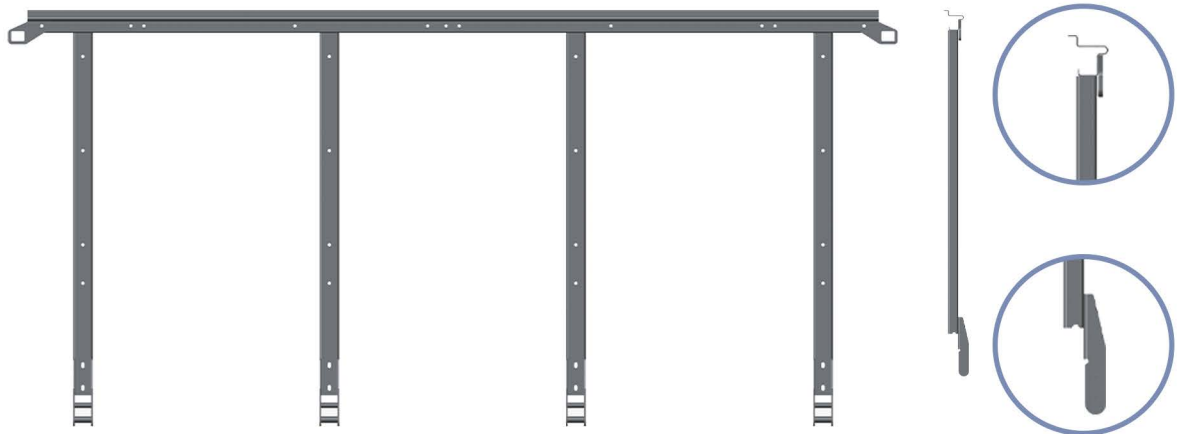

CÓDIGO	ALT.(MM)	LARG.(MM)
FD0008M	800	2212
FD0008S	1000	2212

GRADE LATERAL SUPERIOR

LINHA CARRETAS RODOFORT

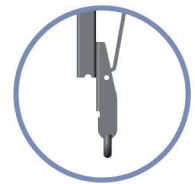
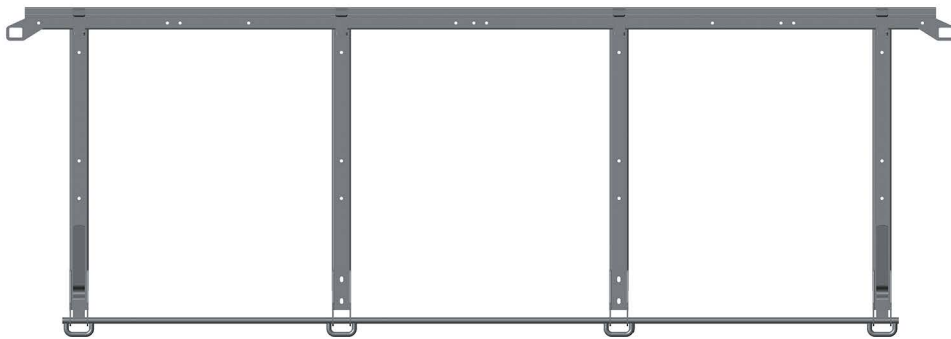

CÓDIGO	ALT.(MM)	LARG.(MM)
FD0009E	800	2430
FD0009G	1000	2430

GRADE TRASEIRA INFERIOR

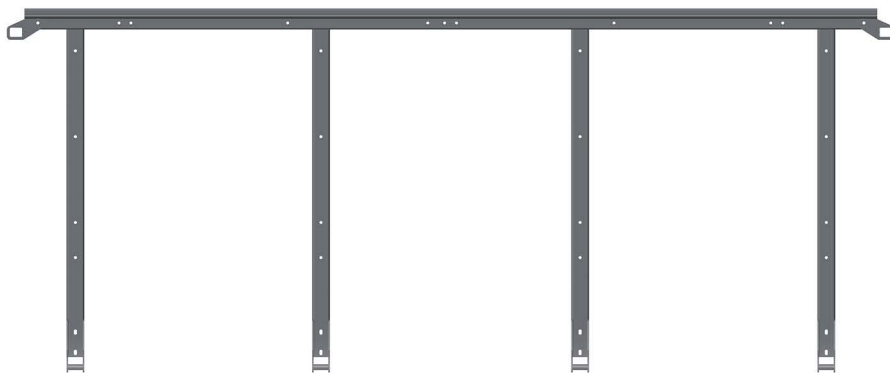

CÓDIGO	ALT.(MM)	LARG.(MM)
FD0011E	800	2430
FD0011G	1000	2430

GRADE TRASEIRA SUPERIOR

LINHA FUEIROS RODOFORT

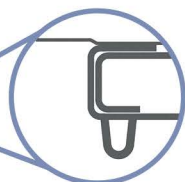

CÓDIGO	ALT.(MM)	LARG.(MM)
FD0115E	800	104
FD0115G	1000	104

FUEIRO LATERAL INFERIOR

CÓDIGO	ALT.(MM)	LARG.(MM)
FD0110E	800	104
FD0110G	1000	104

FUEIRO LATERAL SUPERIOR

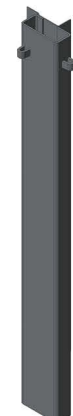

CÓDIGO	ALT.(MM)	LARG.(MM)
FD0117E	800	104
FD0117G	1000	104

FUEIRO DE CANTO INFERIOR DIREITO

CÓDIGO	ALT.(MM)	LARG.(MM)
FD0118E	800	104
FD0118G	1000	104

FUEIRO DE CANTO INFERIOR ESQUERDO

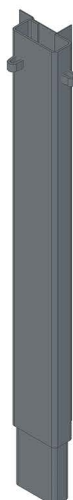

CÓDIGO	ALT.(MM)	LARG.(MM)
FD0113E	800	104
FD0113G	1000	104

FUEIRO DE CANTO SUPERIOR DIREITO

CÓDIGO	ALT.(MM)	LARG.(MM)
FD0114E	800	104
FD0114G	1000	104

FUEIRO DE CANTO SUPERIOR ESQUERDO

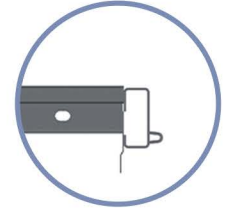
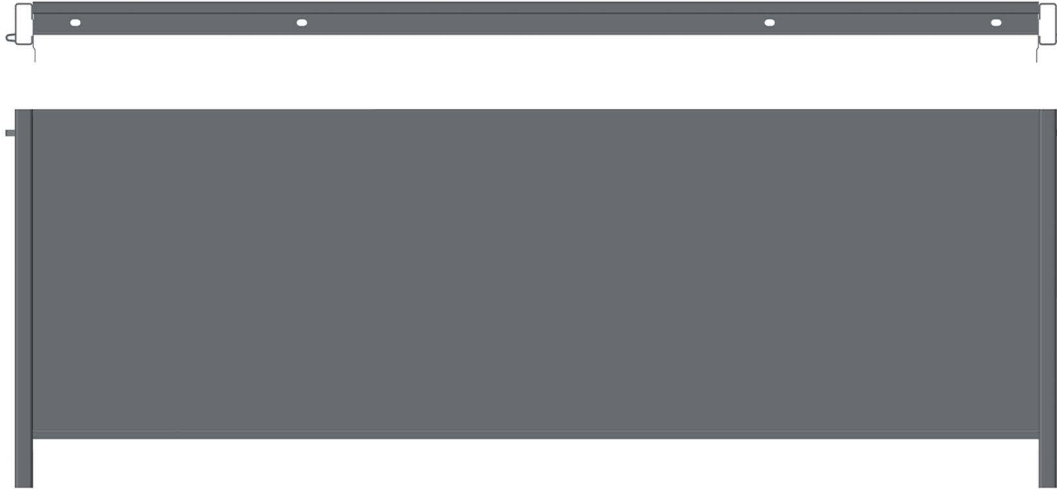
LINHA FRONTAIS RODOFORT



CÓDIGO	ALT.(MM)
--------	----------

FD0306E	800
---------	-----

FD0306G	1000
---------	------

FRONTAL INFERIOR

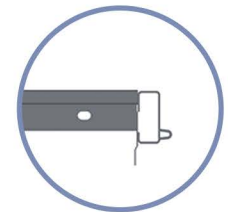
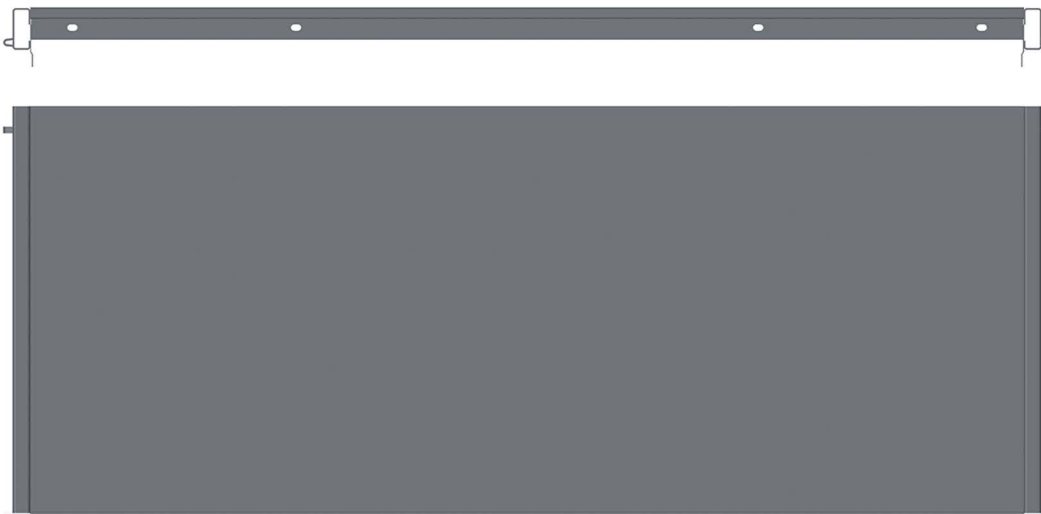

CÓDIGO	ALT.(MM)
--------	----------

FD0307E	800
---------	-----

FD0307G	1000
---------	------

FRONTAL SUPERIOR

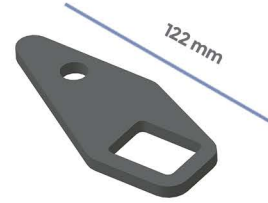

CÓDIGO	COMP.(MM)
--------	-----------

FD0027EA	697
----------	-----

FD0027GA	897
----------	-----

COLUNA INFERIOR E SUPERIOR

FD0020

ENGATE FÊMEA INFERIOR E SUPERIOR



FD0205

PERFIL DIANTEIRO
RODOFORT

FD0204

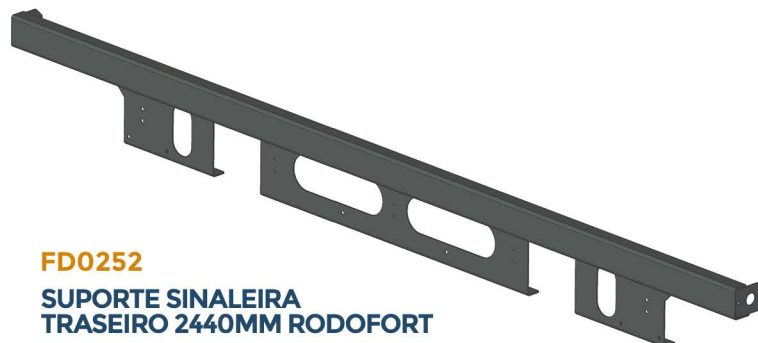
PERFIL LATERAL SEM FURAÇÃO
2210MM RODOFORT

FD0252

SUPORTE SINALEIRA
TRASEIRO 2440MM RODOFORT

SUportes

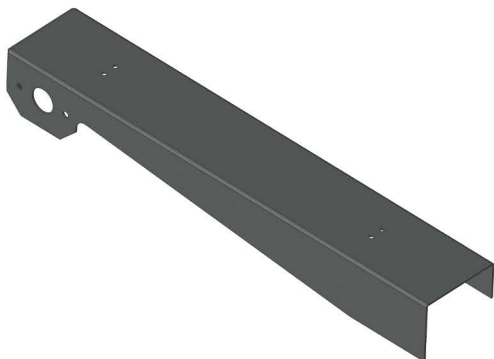

FD0251
SUPOORTE LANTERNA
DIANTEIRO DOLLY RODOFORT
LADO DIREITO



FD0251A
SUPOORTE LANTERNA
DIANTEIRO DOLLY RODOFORT
LADO ESQUERDO

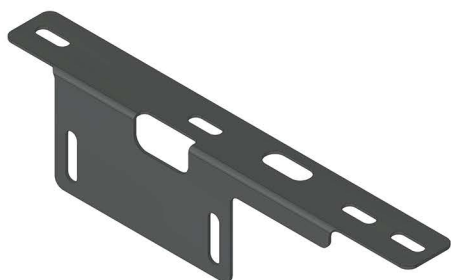

FD0253
SUPOORTE SINALEIRA DE REGULAGEM
RODOFORT LADO DIREITO

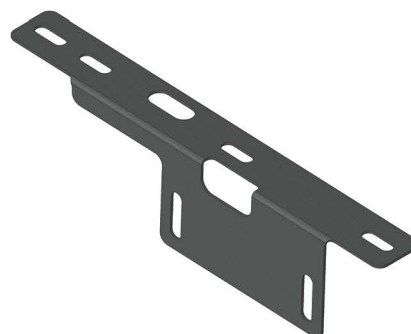

FD0253A
SUPOORTE SINALEIRA DE REGULAGEM
RODOFORT LADO ESQUERDO



FD0254
SUPOORTE PARALAMA
RODOFORT



FD0255
SUPOORTE PARALAMA TRASEIRO
RODOFORT LADO DIREITO/ESQUERDO

LINHA CARRETAS ESTRADA

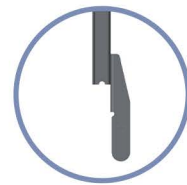
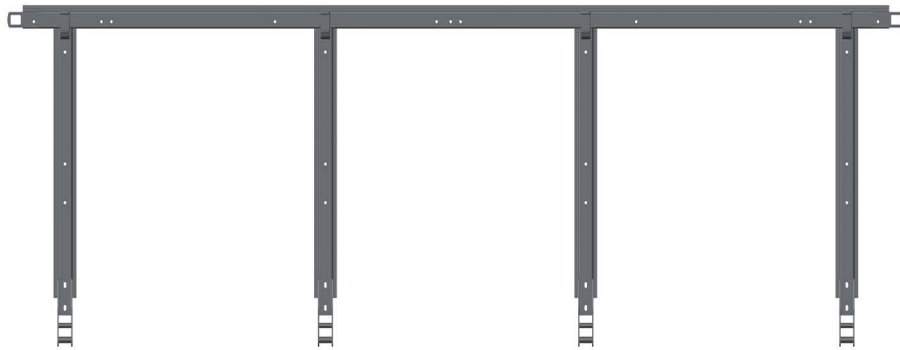

CÓDIGO	ALT.(MM)	LARG.(MM)
--------	----------	-----------

FE0001O	800	2965
---------	-----	------

GRADE LATERAL INFERIOR

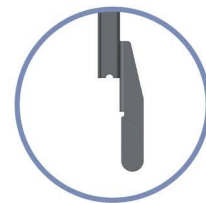
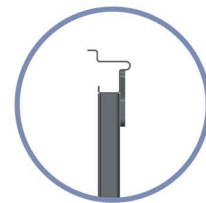
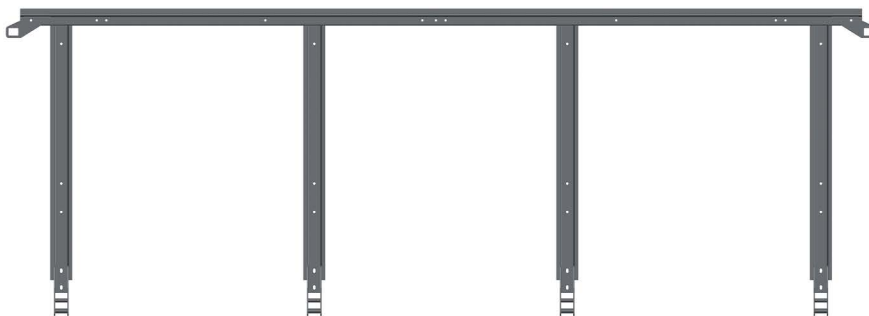

CÓDIGO	ALT.(MM)	LARG.(MM)
--------	----------	-----------

FE0003U	1000	2965
---------	------	------

GRADE LATERAL SUPERIOR

LINHA CARRETAS ESTRADA

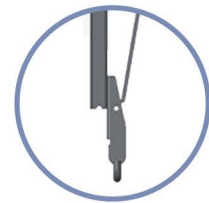
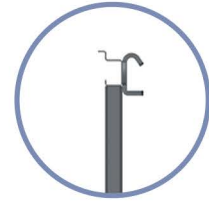
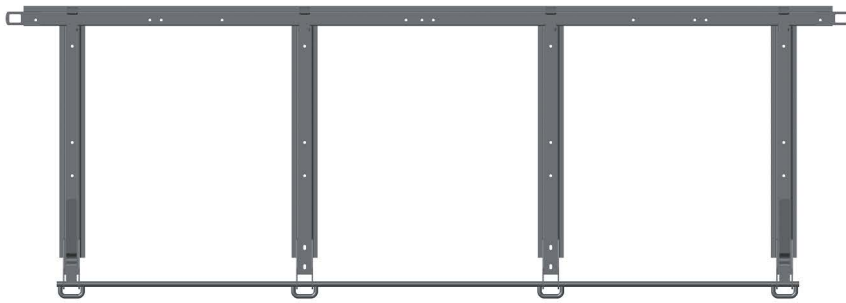

CÓDIGO	ALT.(MM)	LARG.(MM)
FE0004E	800	2430

GRADE TRASEIRA INFERIOR

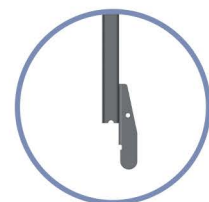
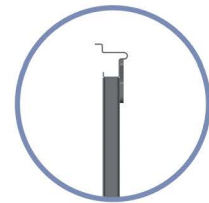
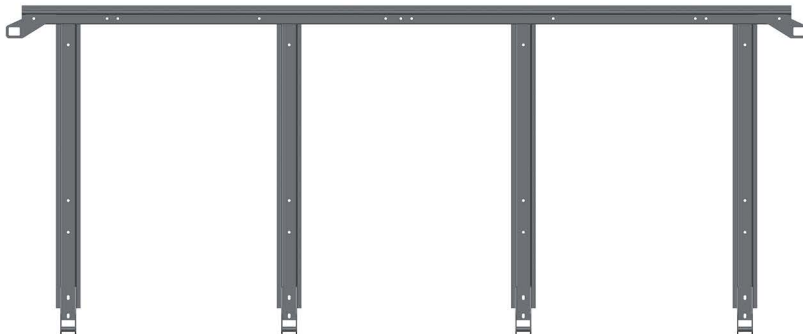

CÓDIGO	ALT.(MM)	LARG.(MM)
FE0006G	1000	2430

GRADE TRASEIRA SUPERIOR

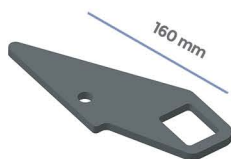

FE0020A
ENGATE FÊMEA INFERIOR

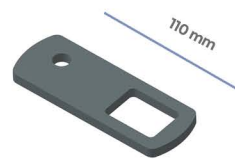

FE0020B
ENGATE FÊMEA SUPERIOR

LINHA CARRETAS RANDON



CÓDIGO	COMP.(MM)
--------	-----------

FR0402F	815
---------	-----

FR0402D	785
---------	-----

FR0402B	765
---------	-----

**MÃO FRANCESA TRAVESSA
LADO DIREITO**

(entre chassi 960mm)



CÓDIGO	COMP.(MM)
--------	-----------

FR0402E	815
---------	-----

FR0402C	785
---------	-----

FR0402A	765
---------	-----

**MÃO FRANCESA TRAVESSA
LADO ESQUERDO**

(entre chassi 960mm)



CÓDIGO	COMP.(MM)
--------	-----------

FR0403D	765
---------	-----

FR0403B	735
---------	-----

**MÃO FRANCESA TRAVESSA
LADO DIREITO**

(entre chassi 1055mm)



CÓDIGO	COMP.(MM)
--------	-----------

FR0403C	765
---------	-----

FR0403A	735
---------	-----

**MÃO FRANCESA TRAVESSA
LADO ESQUERDO**

(entre chassi 1055mm)

DIVERSOS



FR0838 - LADO DIREITO
FR0838A - LADO ESQUERDO
ACABAMENTO DIANTEIRO
SUPERIOR DO SIDER

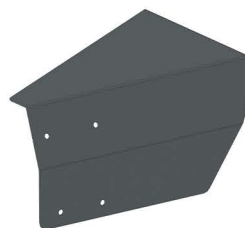

FR0837 - LADO DIREITO
FR0837A - LADO ESQUERDO
ACABAMENTO TRASEIRO
SUPERIOR DO SIDER



FR0839
DESLIZA FIO PARA SIDER
LADO DIREITO/ESQUERDO

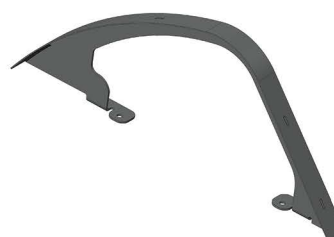

FR0839A
DESLIZA FIO PARA BAÚ
LADO DIREITO/ESQUERDO

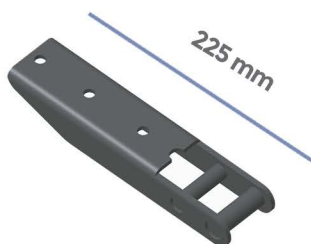

FR0026C
DOBRADIÇA TAMPA MODELO
ECOPLATÉ 3 (ZINCADO BRANCO)

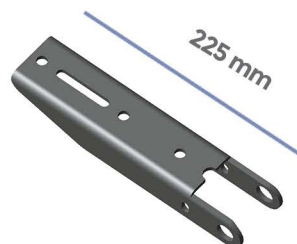

FR0014B
DOBRADIÇA DO TOMBADOR INFERIOR
ECOPLATÉ (ZINCADO BRANCO)

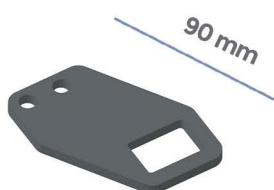

FR0025
ENGATE FÊMEA SUPERIOR
RANDON ECOPLATE 3
(ZINCADO BRANCO)

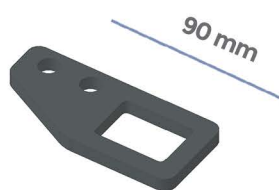

FR0021
ENGATE FÊMEA INFERIOR
RANDON ECOPLATE 3
(ZINCADO BRANCO)

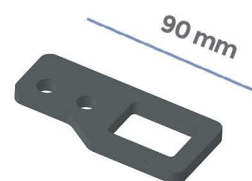

FR0023
ENGATE FÊMEA DA TAMPA
TRASEIRA INFERIOR RANDON
ECOPLATE 3 (ZINCADO BRANCO)



FR0262
SUPORTE PLACA/SINALEIRA
BASCULANTE RANDON
LADO ESQUERDO



FR0263
SUPORTE DE FIXAÇÃO PARA
SINALEIRA DO DOLLY
RANDON MOD 2022



FR0264
SUPORTE DA PLACA DA
BASCULANTE RANDON
LADO ESQUERDO



FR0603
MANCAL DO SUSPENSOR
MODELO RANDON

LINHA CARRETAS TITANIUM

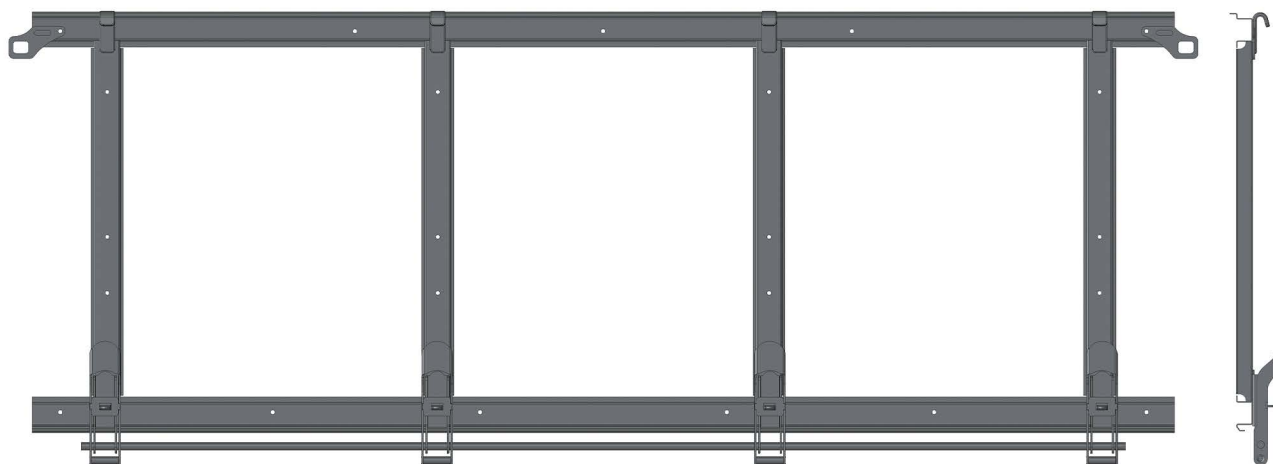

CÓDIGO	ALT.(MM)	LARG.(MM)
FN0003C	640	2445
FN0003D	790	2445
FN0003E	890	2445
FN0003F	990	2445

GRADE TRASEIRA INFERIOR



FN0010A CONJUNTO TAMPA TASEIRA TITANIUM

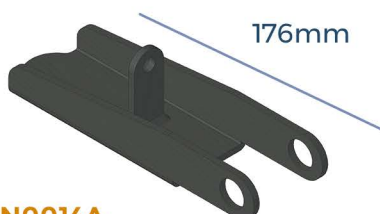

FN0014A DOBRADIÇA DO TOMBADOR INFERIOR TITANIUM



FN0015A GANCHO TOMBADOR TITANIUM

OBS: AS DOBRADIÇAS ORIGINAIS DA LINHA TITANIUM SÃO DE FERRO FUNDIDO, A FADO DESENVOLVEU/FORNECE EM AÇO CARBONÓ.

SUPORTES

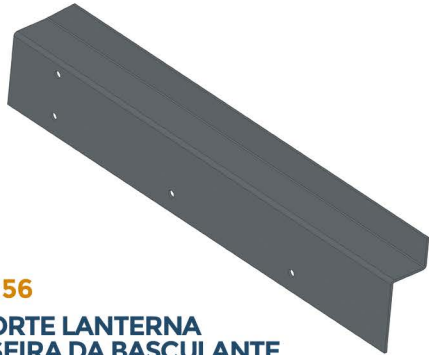
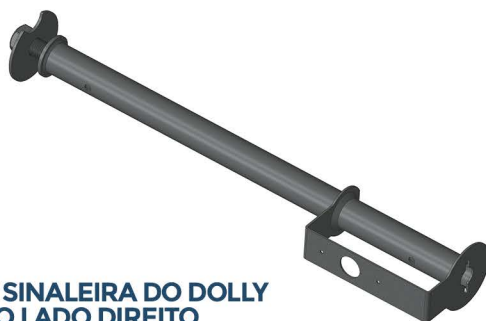
**FL0256****SUPORE LANTERNA
TRASEIRA DA BASCULANTE
LIBRELATO LADO DIREITO****FL0256A****SUPORE LANTERNA
TRASEIRA DA BASCULANTE
LIBRELATO LADO ESQUERDO****FL0904****SUPORE SINALEIRA
DIANTEIRA DA BASCULANTE
LIBRELATO LADO DIREITO****FL0904A****SUPORE SINALEIRA
DIANTEIRA DA BASCULANTE
LIBRELATO LADO ESQUERDO****FL0905****SUPORE SINALEIRA DO DOLLY
LIBRELATO LADO DIREITO****FL0905A****SUPORE SINALEIRA DO DOLLY
LIBRELATO LADO ESQUERDO****FL0906****SUPORE SINALEIRA DA
BASCULANTE LIBRELATO
LADO DIREITO****FL0906A****SUPORE SINALEIRA DA
BASCULANTE LIBRELATO
LADO ESQUERDO**

LINHA PARA BAÚ



F4099
ABRAÇADEIRA INTERNA
DO BAÚ Ø 1/2"



F4129
CONJUNTO ABRAÇADEIRA INTERNA
DE BAÚ PARA TUBO Ø 33,7



F4131
CONJUNTO ABRAÇADEIRA INTERNA
DE BAÚ PARA TUBO Ø 26,9



F4128
CONJUNTO TRAVA ALAVANCA
DE BAÚ



F4133
TRAVA PORTA PARA BAÚ (MACHO)



F4133A
TRAVA PORTA PARA BAÚ (FÊMEA)

FACCHINI

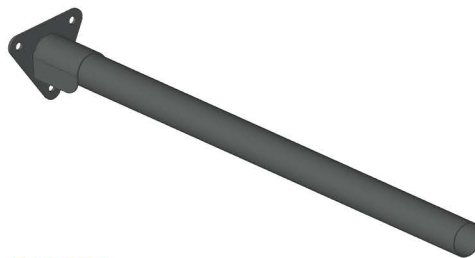
**FF0021**TRANCA MODERNA DO TRUCK
(ZINCADO BRANCO)**F4007A**

SUPORTE PARALAMA FACCHINI LEVE

GUERRA

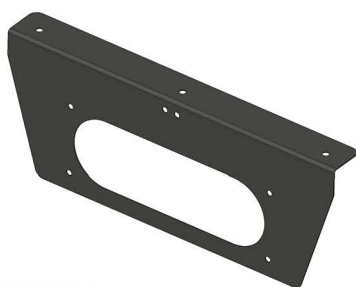
**FG0252**

SUPORTE SINALEIRA GUERRA

FG0252A

SUPORTE SINALEIRA GUERRA (LEVE)

DIVERSOS

**F4141**SUPORTE DE SINALEIRA
MODELO UNIVERSAL

DIVERSOS

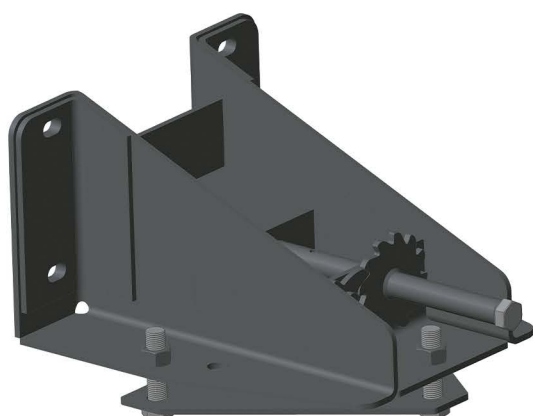
**F4023**SUPORTE ESTEPE COM
CATRACA REFORÇADO**F4028P**PORCA M8 TRAVANTE PARA AS PRESILHAS
DAS TAMPAS (100 UNIDADES)

CAIXAS DE FERRAMENTAS

MODELOS BASCULANTE/CAVALO MECÂNICO



F4126

CAIXA DE FERRAMENTA DO CAVALO MECÂNICO 300 X 900 X 300mm



F4127

CAIXA DE FERRAMENTA DA BASCULANTE 300 X 500 X 300mm

A FADO DESENVOLVE CAIXAS DE FERRAMENTAS CONFORME A SUA NECESSIDADE.
Consulte o representante da sua região ou fábrica.

CONHEÇA A FADO

Leia o QR Code e assista o vídeo institucional no  YouTube



Plane

Revisão Outubro/2023



FAÇA O SEU ORÇAMENTO:

 (54) 3291.1507  (54) 99200.5195  pedido@fado.com.br  www.fado.com.br

VRS 315 Km 3,9 n° 718 São Marcos/RS Cep 95190-000

  fadoautopecas  fadoautopecas