

FADO[®] **40**
Anos



BAIXE O CATALOGO FADO



WHATSAPP COMERCIAL FADO

**PEÇAS PARA
IMPLEMENTOS
RODOVIÁRIOS**
CATÁLOGO 2022



CONHEÇA A FADO, FABRICANTE NACIONAL DE PEÇAS PARA CARRETAS E ESCAPAMENTOS

Qualidade como missão e filosofia, essa é a diretriz da Fado, fabricante nacional de escapamentos e acessórios automotivos e peças para implementos rodoviários. Produzindo também linha completa de suportes flexíveis, a Fado oferece soluções inteligentes e modernas para o transporte, indústria e construção civil.



A mais completa linha de escapamentos automotivos para caminhões do Brasil

Com mais de 40 anos de atuação e liderança no mercado em que atua, a Fado está instalada em São Marcos, capital gaúcha do caminhoneiro, com 8 mil m² de área construída, oferecendo a mais completa linha de escapamentos automotivos para transporte pesado no Brasil, atendendo o setor de reposição para todas as grandes montadoras de caminhões.



Qualidade e inovação para o setor de Implementos Rodoviários

A Fado trouxe ao setor de implementos rodoviários inovação, qualidade, comprometimento e fabricação de produtos personalizados, de acordo com o perfil de cada cliente. Em 2017 iniciou a linha de fabricação de peças para carretas, sempre focada na qualidade e filosofia da Fado, hoje contando com amplo mix de produtos, atendendo o setor de reposição das grandes montadoras.



Desenvolvimento de produto e logística internalizados

A Fado possui o setor de Pesquisa e Desenvolvimento de Produto internalizado, garantindo a manutenção de um alto padrão de exigência e qualidade em todas as etapas e agilidade no atendimento de novas necessidades de mercado. Também possui logística própria de distribuição, oferecendo segurança na entrega, desde a saída da fábrica até a chegada aos revendedores, em diferentes pontos do Brasil e América do Sul. Além disso, mantém seus processos em conformidade com os requisitos da NBR ISO 9001.

Confiança e segurança nas estradas pelo mundo.

Qualidade reconhecida internacionalmente

A Fado está presente na Argentina, Brasil, Chile, Paraguai, Peru e Uruguai



ACESSE O SITE FADO.COM.BR



WHATSAPP COMERCIAL FADO



ÍNDICE

SUPER LANÇAMENTOS	04
RANDON	
Graneleira.....	12
Sider.....	36
Dolly.....	44
Basculante.....	45
GUERRA	
Graneleira.....	46
LIBRELATO	
Graneleira.....	66
Dolly.....	87
Basculante.....	87
NOMA	
Graneleira.....	88
Dolly.....	101
FACCHINI	
Graneleira.....	102
Sider.....	110
Dolly.....	116
DOLLY	
FACCHINI.....	116
RANDON.....	117
LIBRELATO.....	118
GUERRA.....	118
NOMA.....	118
TRUCK	119
BASCULANTE	120
PARACHOQUES	121
CAIXA DE FERRAMENTAS	125
DIVERSOS	126
PATIM DE FREIO	135

SUPER LANÇAMENTOS

FADO 40
Anos

EX LU IVO

- Travas laterais, proporcionando melhor fechamento e vedação;
- Estampo lateral, garantindo melhor resistência e evitando vibração;
- Opção de trava central com chave;
- Borracha com maior densidade, nas quatro bordas, evitando a entrada de pó e água.

CAIXA DE FERRAMENTAS

PREMIUM



• SOBRE ESTE PRODUTO

FECHADURA PADRÃO



cód.	A	X	C	X	P
F4043	500	X	500	X	500mm
F4100	600	X	600	X	600mm
F4102	600	X	535	X	600mm
F4123	500	X	600	X	600mm
F4103	600	X	1000	X	600mm
F4101	600	X	1140	X	600mm
F4113	600	X	900	X	600mm

FECHADURA PLÁSTICA



cód.	A	X	C	X	P
F4043A	500	X	500	X	500mm
F4108	600	X	600	X	600mm
F4109	600	X	535	X	600mm
F4123A	500	X	600	X	600mm
F4110	600	X	1000	X	600mm
F4111	600	X	1140	X	600mm
F4113A	600	X	900	X	600mm

FECHADURA INOX



cód.	A	X	C	X	P
F4043B	500	X	500	X	500mm
F4108A	600	X	600	X	600mm
F4109A	600	X	535	X	600mm
F4123B	500	X	600	X	600mm
F4110A	600	X	1000	X	600mm
F4111A	600	X	1140	X	600mm
F4113B	600	X	900	X	600mm

FECHADURA METAL COR PRETA



cód.	A	X	C	X	P
F4043C	500	X	500	X	500mm
F4108B	600	X	600	X	600mm
F4109B	600	X	535	X	600mm
F4123C	500	X	600	X	600mm
F4110B	600	X	1000	X	600mm
F4111B	600	X	1140	X	600mm
F4113C	600	X	900	X	600mm

A Fado desenvolve Caixas de Ferramentas conforme a sua necessidade.
(consulte o representante da sua região ou fábrica)

CAIXA DE FERRAMENTAS PREMIUM FADO

Durabilidade e Praticidade pensados para cada espaço.



F4112
Caixa de Ferramenta
300 X 500 X 500mm
Furgão - Sem Estampo



F4100A
Trava Lateral
Caixa de Ferramenta



F4100B
Trava Central
Caixa de Ferramenta



F4082
Suporte Reto
Caixa de Ferramenta



F4082A
Suporte "Z" 50mm
Caixa de Ferramenta

F4082B
Suporte "Z" 95mm
Caixa de Ferramenta



F4082C
Suporte p/ Caixa
de Cozinha LD/LE
(conjunto 2 peças)

COMPÁTIVEL COM CARRETAS GRANELEIRAS RANDON

TRAVESSA PASSANTE



TRAVESSA PASSANTE MEDIDA ENTRE CHASSI 960mm

FR0400 - 2490mm
FR0400A - 2530mm
FR0400B - 2590mm

TRAVESSA PASSANTE MEDIDA ENTRE CHASSI 1055mm

FR0401 - 2530mm
FR0401A - 2590mm



SUPER LANÇAMENTOS

FADO 40
Anos

CARENAGEM LATERAL

COMPÁTIVEL COM LINHA
SCANIA NTC A PARTIR DE 2018

Produzida em aço carbono

- +++ MAIS LEVE
- +++ MAIS RESISTENTE
- +++ MAIS ECONÔMICO



CONJUNTOS CARENAGEM
LATERAL COMPATÍVEIS
COM SCANIA NTC

F2310C
3100mm ENTRE EIXOS - SAÍDA DO
ESCAPAMENTO ORIGINAL CENTRAL

F2310D
3100mm ENTRE EIXOS - SAÍDA DO
ESCAPAMENTO ORIGINAL LD

F2310E
3100mm ENTRE EIXOS - SAÍDA DO
ESCAPAMENTO ORIGINAL LE

F2311C
3350mm ENTRE EIXOS - SAÍDA DO
ESCAPAMENTO ORIGINAL CENTRAL

F2311D
3350mm ENTRE EIXOS - SAÍDA DO
ESCAPAMENTO ORIGINAL LD

F2311E
3350mm ENTRE EIXOS - SAÍDA DO
ESCAPAMENTO ORIGINAL LE

F2312C
3550mm ENTRE EIXOS - SAÍDA DO
ESCAPAMENTO ORIGINAL CENTRAL

F2312D
3550mm ENTRE EIXOS - SAÍDA DO
ESCAPAMENTO ORIGINAL LD

F2312E
3550mm ENTRE EIXOS - SAÍDA DO
ESCAPAMENTO ORIGINAL LE

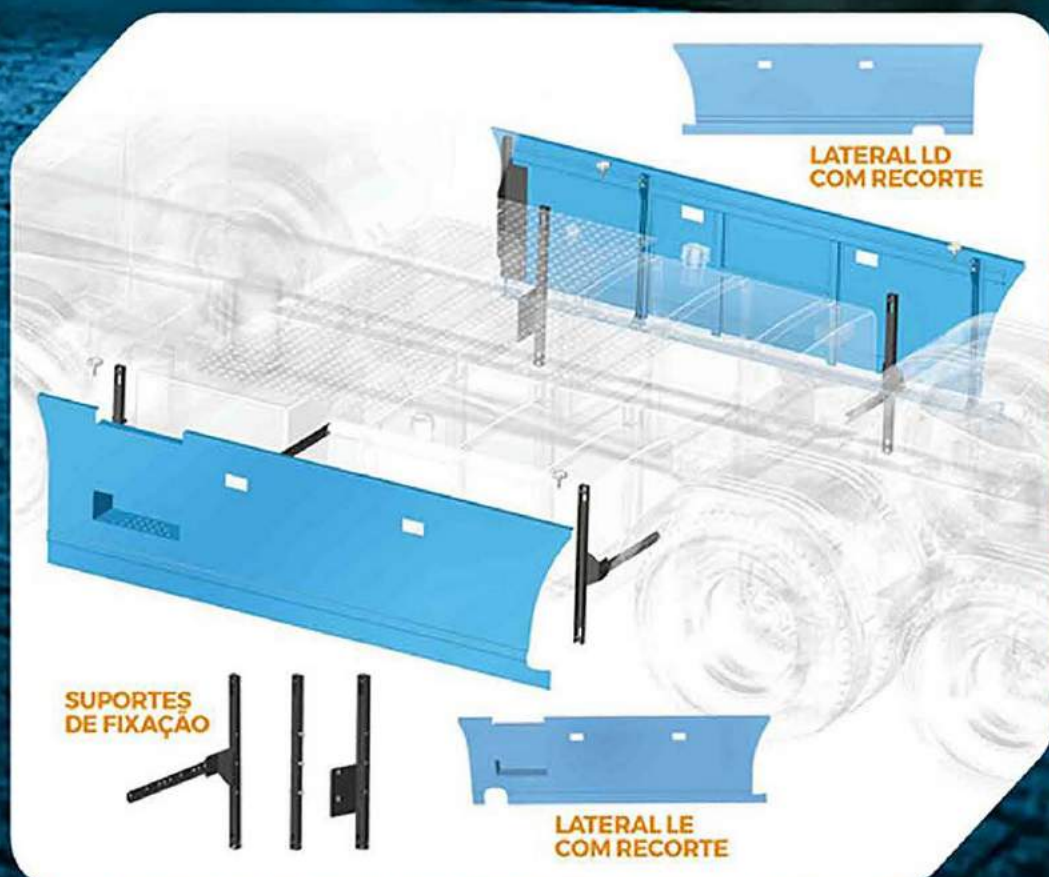

*Laterais de proteção nas medidas conforme entre eixos - Cor meramente ilustrativa

FADO 40
Anos

SUPER LANÇAMENTOS

CARENAGEM LATERAL

COMPÁTIVEL COM LINHA
VOLVO PARTIR DE 2016

Produzida em aço carbono

- ++ **MAIS LEVE**
- ++ **MAIS RESISTENTE**
- ++ **MAIS ECONÔMICO**

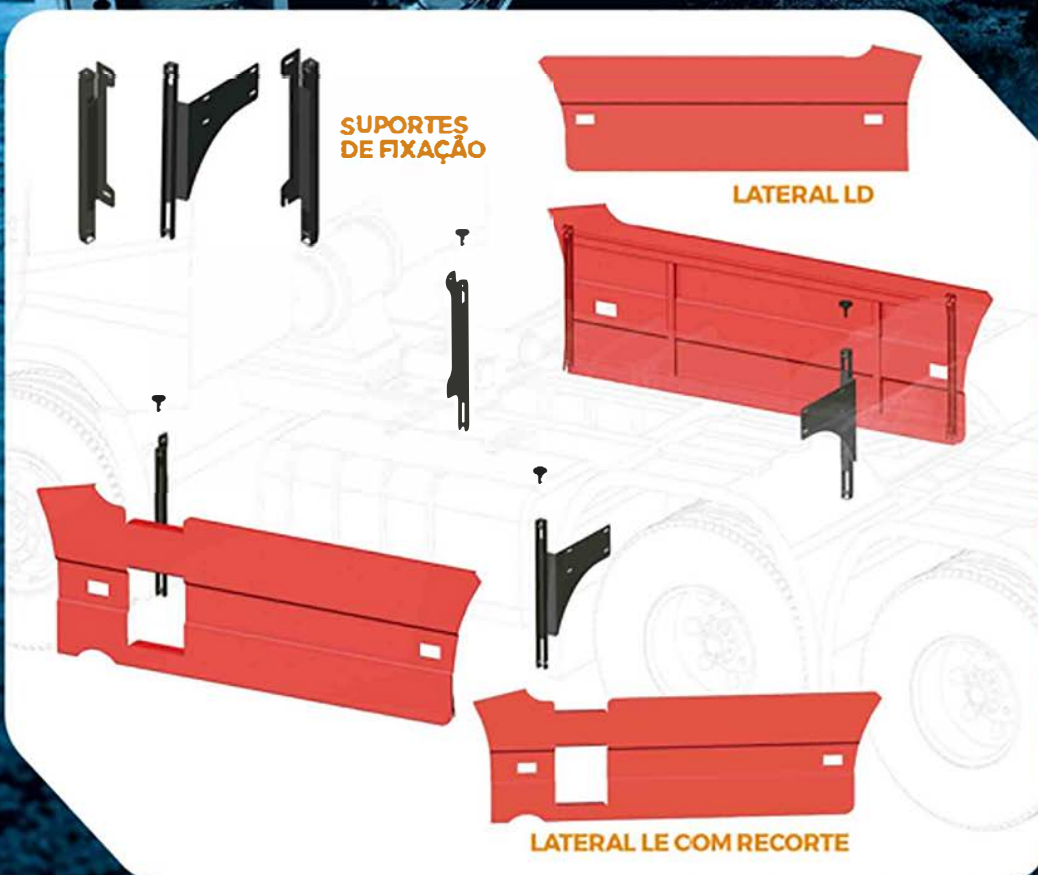

**CONJUNTOS CARENAGEM
LATERAL COMPATÍVEIS
COM VOLVO FH / FM**

F7916
3200mm ENTRE EIXOS

F7917
3500mm ENTRE EIXOS

F7918
3600mm ENTRE EIXOS

F7919
3700mm ENTRE EIXOS

*Laterais de proteção nas medidas conforme entre eixos - Cor meramente ilustrativa

SUPER LANÇAMENTOS

FADO 40
Anos

TRAVAS ANTIFURTOS



F2145
Trava Antifurto do capô Scania
124P, 124G, 360, 380, 400 e 420



F2146
Trava Antifurto do Farol
lado direito Scania
a partir de 2010



F2146A
Trava Antifurto do Farol
lado esquerdo Scania
a partir de 2010



F2147
Trava/Cadeado
Antifurto do servo
de embreagem
compatível com a linha
Scania P/C/R/NTC



F7771
Trava/Cadeado
Antifurto do módulo
de ignição compatível
com a linha Volvo FH
a partir de 2016

RESERVATÓRIO DE AR



F4090
Reservatório de Ar
117 litros com saída "ABS"



F4090A
Reservatório de Ar 117 litros com
saída "ABS" fixação com cinta



F4090B
Reservatório de Ar
73 litros com saída "ABS"

* Cor meramente ilustrativa.

PATIM DE FREIO



CARRETA/TRUCK
Patim de Freio 8" s/ rolete (LD/LE)

APLICAÇÃO	Minitor
Nº ORIGINAL	A322241831
Lona Fras-le	CA-32
Lona Flex	L-638
Lona Duroline	DC332
Lona Thermoid	TH-4516



CARRETA/TRUCK
Patim de Freio 8" s/ rolete (LD/LE)

APLICAÇÃO	Carreta Q plus
Nº ORIGINAL	A322251661
Lona Fras-le	CA-33
Lona Flex	L-636
Lona Duroline	DC333
Lona Thermoid	TH-204



CARRETA/TRUCK
Patim de Freio Traseiro A Ar 7" s/ rolete

APLICAÇÃO	7" Vw - Carretão
Nº ORIGINAL	14.150/14.170 Bz/14.200/14.210 D/16.37 D
	Bz/16.200/16.200 (1/31 - 16.300 -
	22.200/24.200/24.220/24.300/35.000/35.300
	0 (1) 01 HDuk. 16.180 Co (1) - 16.210 Cd (6)
Nº ORIGINAL	172 607 525
Lona Fras-le	FD-88
Lona Flex	L-224
Lona Duroline	DFW988
Lona Thermoid	TH-16

SUPER LANÇAMENTOS

fado.com.br

linha SIDER

COMPÁTIVEL COM CARRETAS FACCHINI

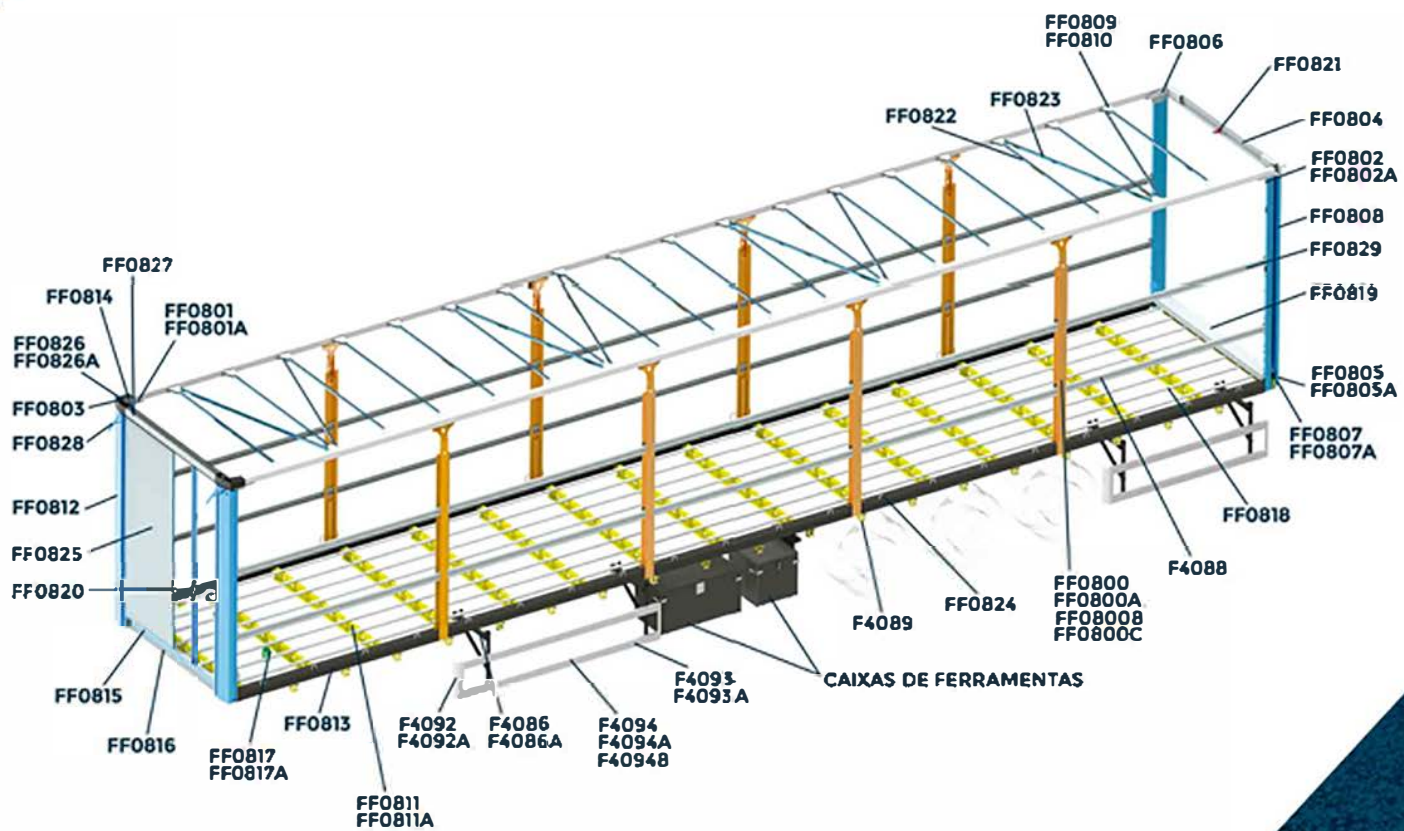

FADO 40
Anos



linha **SIDER**

COMPÁTIVEL COM CARRETAS **RANDON**

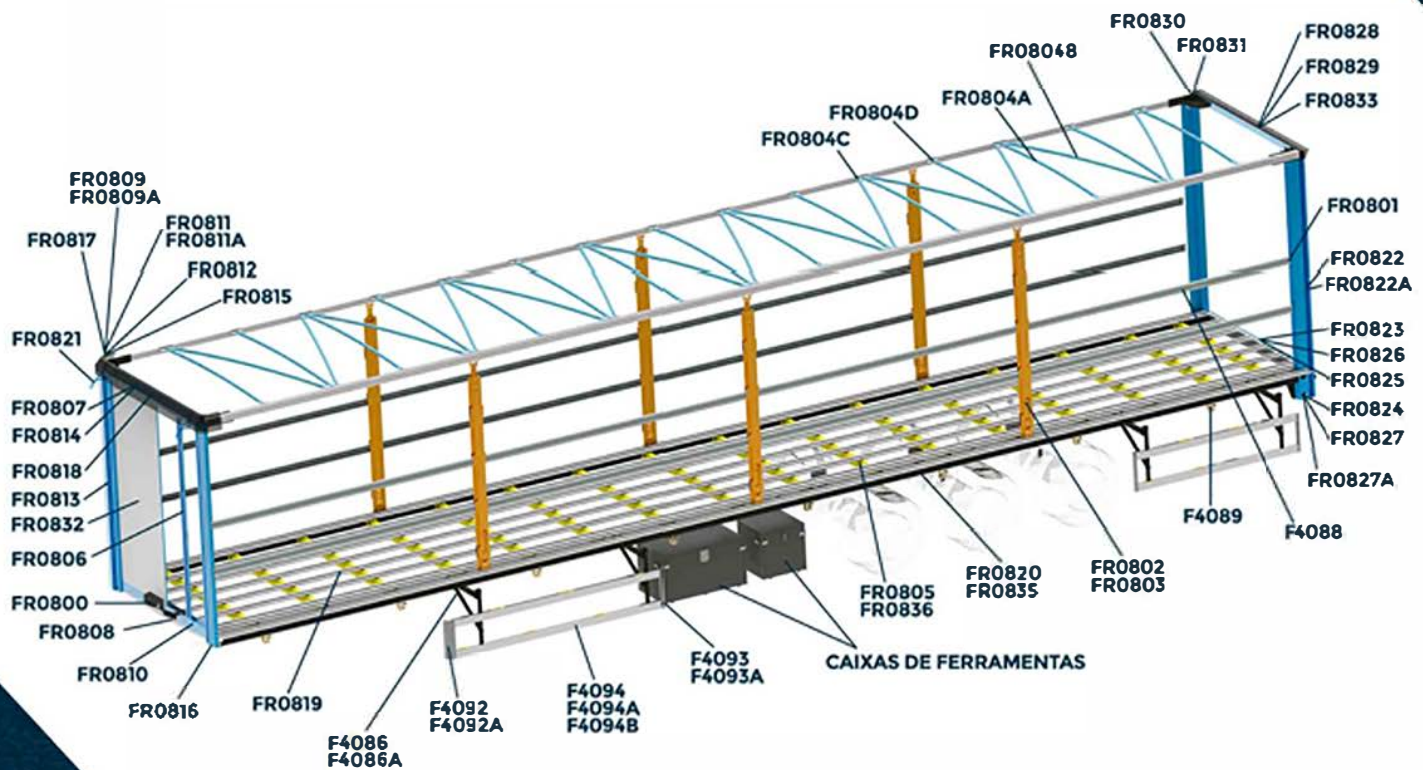

PEÇAS COMPATÍVEIS COM

linha RANDON

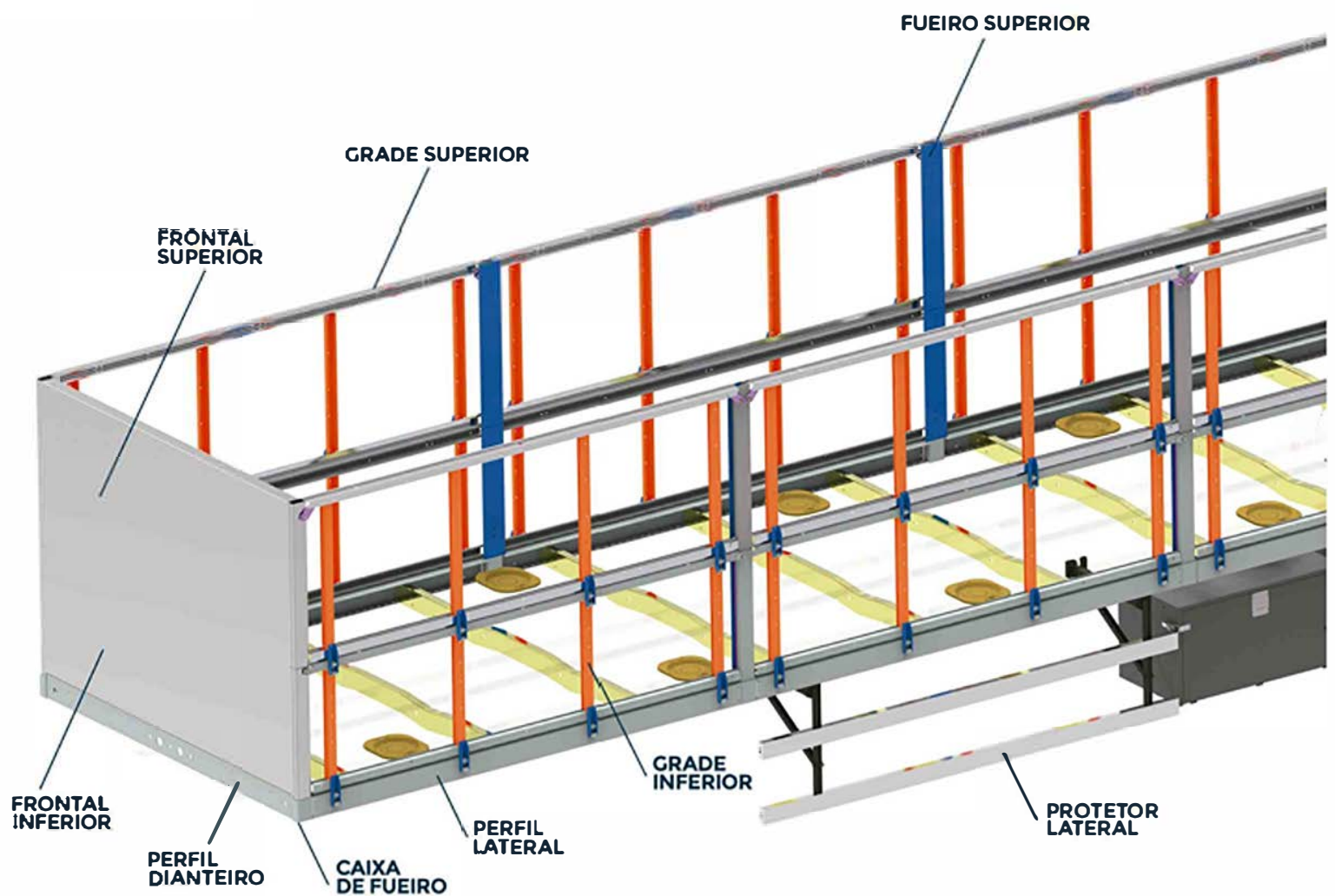

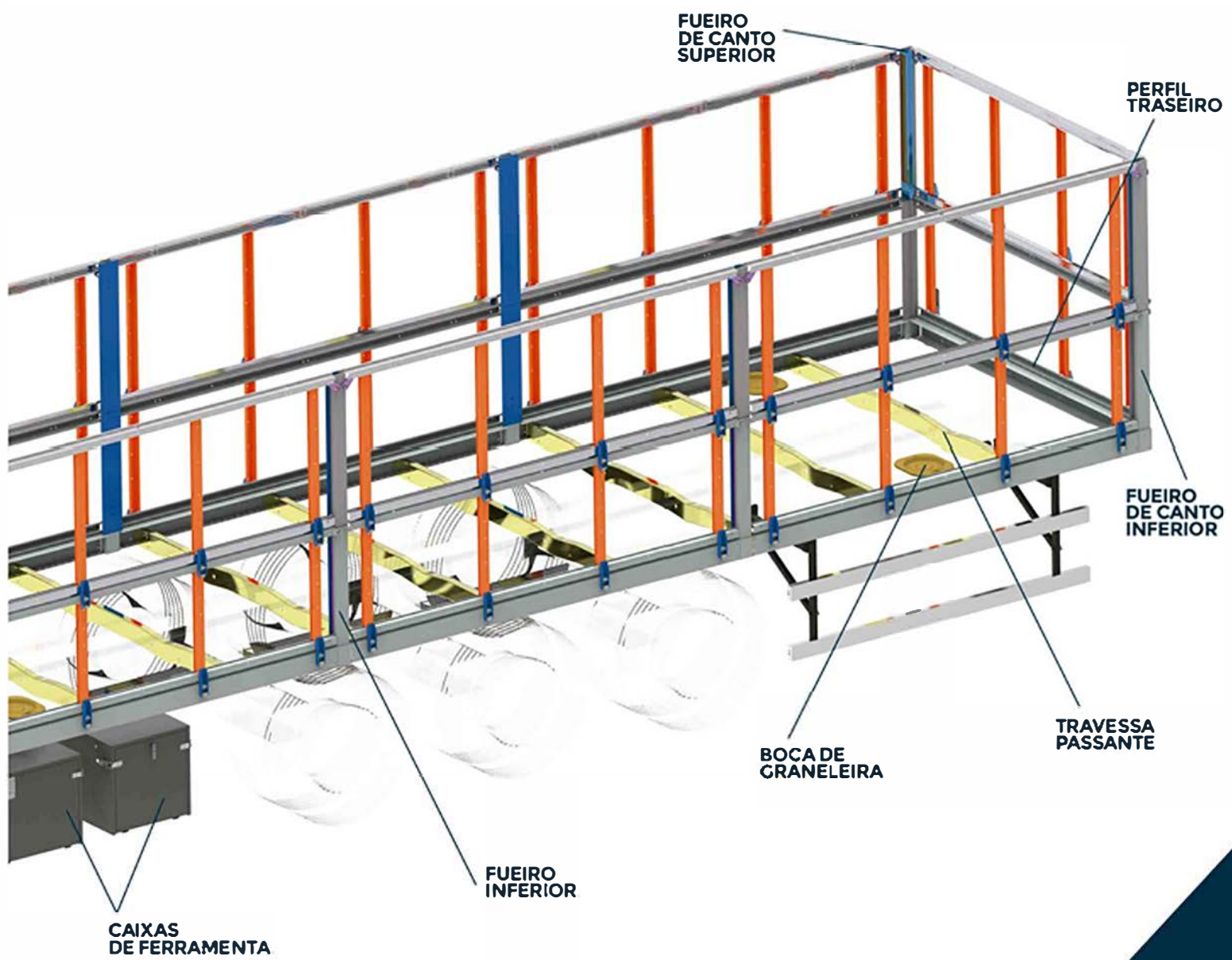

COMPATÍVEL COM LINHA

RANDON



LINHA CARRETAS ANTIGAS

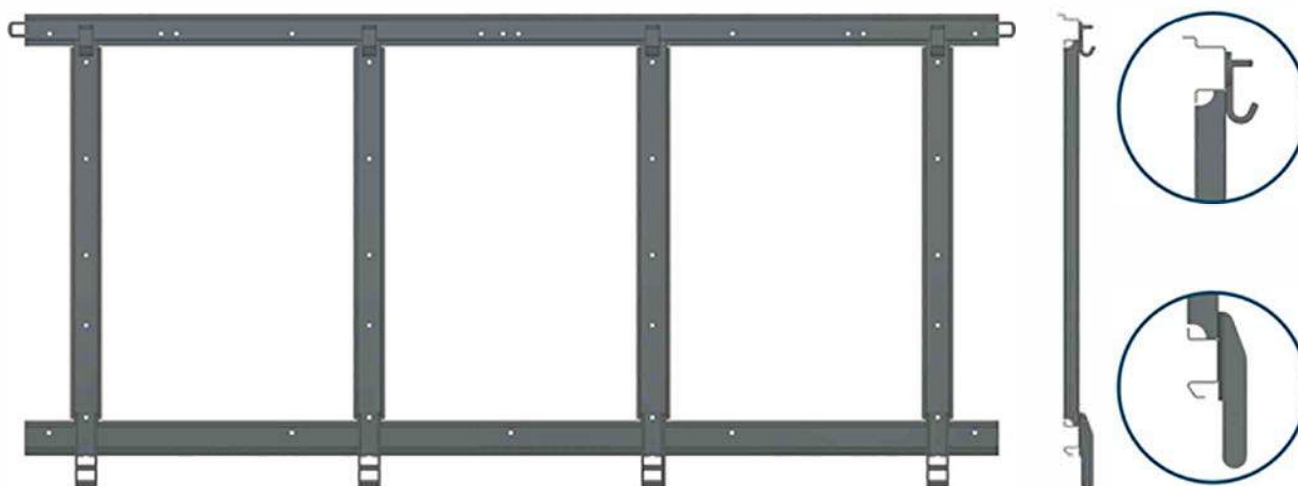

GRADE LATERAL INFERIOR

Código	alt. (mm)	larg. (mm)
FR0001A	550	2220
FR0001B	550	2320
FR0001C	550	2420
FR0001D	550	2960
FR0001E	600	2220
FR0001F	600	2320
FR0001G	600	2420

Código	alt. (mm)	larg. (mm)
FR0001H	600	2960
FR0001I	650	2220
FR0001J	650	2320
FR0001K	650	2420
FR0001L	650	2960
FR0001M	700	2220
FR0001N	700	2320

Código	alt. (mm)	larg. (mm)
FR0001O	700	2420
FR0001P	700	2960
FR0001Q	800	2220
FR0001R	800	2320
FR0001S	800	2420
FR0001T	800	2960
FR0001U	900	2220

Código	alt. (mm)	larg. (mm)
FR0001V	900	2320
FR0001X	900	2420
FR0001Z	900	2960
FR0001AA	1000	2220
FR0001AB	1000	2320
FR0001AC	1000	2420
FR0001AD	1000	2960

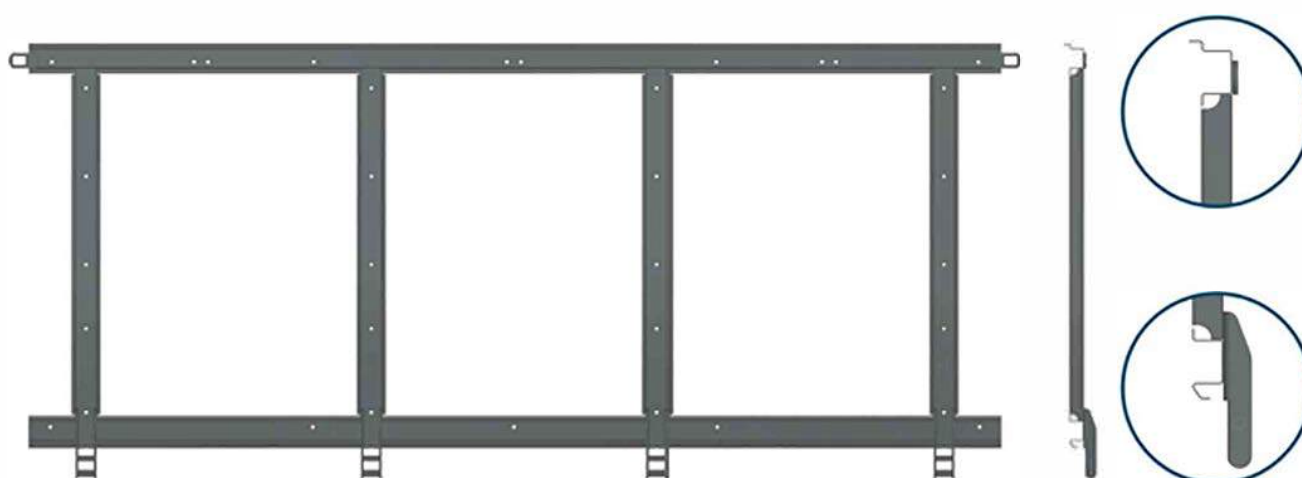

GRADE LATERAL SUPERIOR

Código	alt. (mm)	larg. (mm)
FR0002A	550	2220
FR0002B	550	2320
FR0002C	550	2420
FR0002D	550	2960
FR0002E	600	2220
FR0002F	600	2320
FR0002G	600	2420

Código	alt. (mm)	larg. (mm)
FR0002H	600	2960
FR0002I	650	2220
FR0002J	650	2320
FR0002K	650	2420
FR0002L	650	2960
FR0002M	700	2220
FR0002N	700	2320

Código	alt. (mm)	larg. (mm)
FR0002O	700	2420
FR0002P	700	2960
FR0002Q	800	2220
FR0002R	800	2320
FR0002S	800	2420
FR0002T	800	2960
FR0002U	900	2220

Código	alt. (mm)	larg. (mm)
FR0002V	900	2320
FR0002X	900	2420
FR0002Z	900	2960
FR0002AA	1000	2220
FR0002AB	1000	2320
FR0002AC	1000	2420
FR0002AD	1000	2960

LINHA CARRETAS ANTIGAS

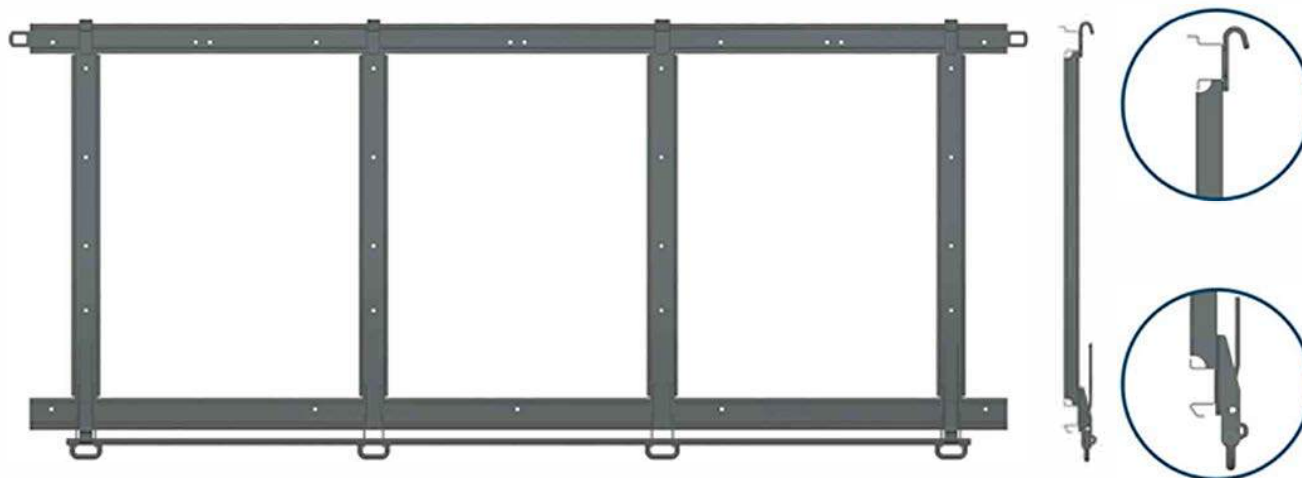

GRADE TRASEIRA INFERIOR

Código	alt. (mm)	larg. (mm)	Código	alt. (mm)	larg. (mm)
FR0004A	550	2420	FR0004E	800	2420
FR0004B	600	2420	FR0004F	900	2420
FR0004C	650	2420	FR0004C	1000	2420
FR0004D	700	2420			

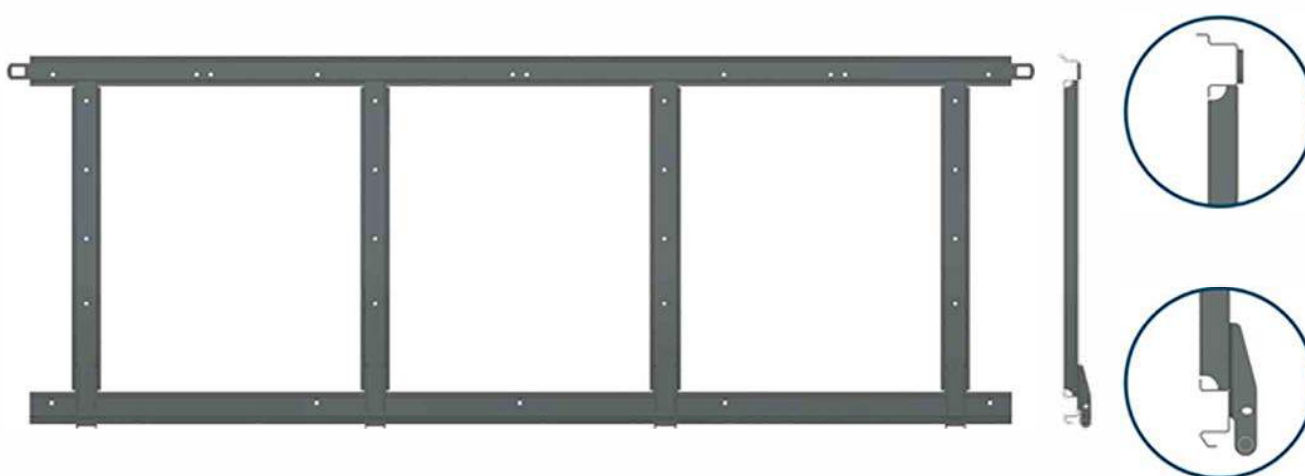

GRADE TRASEIRA SUPERIOR

Código	alt. (mm)	larg. (mm)	Código	alt. (mm)	larg. (mm)
FR0005A	550	2420	FR0005E	800	2420
FR0005B	600	2420	FR0005F	900	2420
FR0005C	650	2420	FR0005C	1000	2420
FR0005D	700	2420			

COMPATÍVEL COM LINHA

RANDON



LINHA FUEIROS ANTIGOS



FUEIRO LATERAL INFERIOR

Código	alt. (mm)	larg. (mm)
FR0103A	550	95
FR0103B	600	95
FR0103C	650	95
FR0103D	700	95
FR0103E	800	95
FR0103F	900	95
FR0103G	1000	95



FUEIRO LATERAL SUPERIOR

Código	alt. (mm)	larg. (mm)
FR0104A	550	95
FR0104B	600	95
FR0104C	650	95
FR0104D	700	95
FR0104E	800	95
FR0104F	900	95
FR0104G	1000	95



FUEIRO DE CANTO INFERIOR DIREITO

Código	alt. (mm)	larg. (mm)
FR0105A	550	95
FR0105B	600	95
FR0105C	650	95
FR0105D	700	95
FR0105E	800	95
FR0105F	900	95
FR0105G	1000	95



FUEIRO DE CANTO INFERIOR ESQUERDO

Código	alt. (mm)	larg. (mm)
FR0106A	550	95
FR0106B	600	95
FR0106C	650	95
FR0106D	700	95
FR0106E	800	95
FR0106F	900	95
FR0106G	1000	95



FUEIRO DE CANTO SUPERIOR DIREITO

Código	alt. (mm)	larg. (mm)
FR0107A	550	95
FR0107B	600	95
FR0107C	650	95
FR0107D	700	95
FR0107E	800	95
FR0107F	900	95
FR0107G	1000	95



FUEIRO DE CANTO SUPERIOR ESQUERDO

Código	alt. (mm)	larg. (mm)
FR0108A	550	95
FR0108B	600	95
FR0108C	650	95
FR0108D	700	95
FR0108E	800	95
FR0108F	900	95
FR0108G	1000	95



COMPATÍVEL COM LINHA

RANDON

LINHA FRONTAIS ANTIGOS

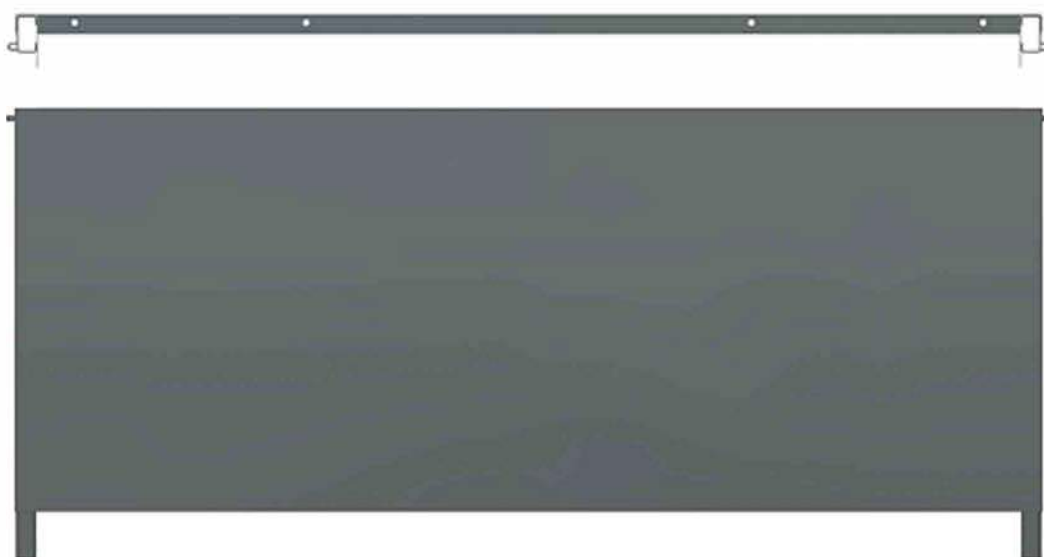

FRONTAL INFERIOR

Código	alt. (mm)	Código	alt. (mm)
FR0300A	550	FR0300E	800
FR0300B	600	FR0300F	900
FR0300C	650	FR0300G	1000
FR0300D	700		

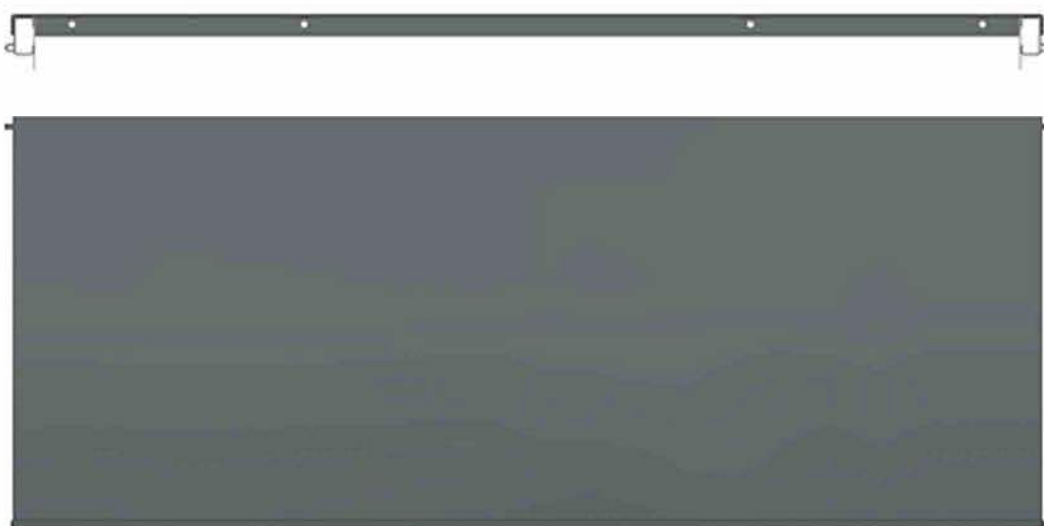

FRONTAL SUPERIOR

Código	alt. (mm)	Código	alt. (mm)
FR0301A	550	FR0301E	800
FR0301B	600	FR0301F	900
FR0301C	650	FR0301G	1000
FR0301D	700		

COMPATÍVEL COM LINHA

RANDON



LINHA CARRETAS NOVAS

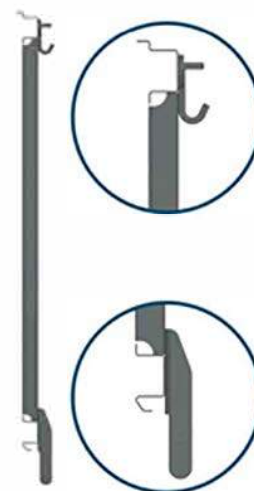

GRADE LATERAL INFERIOR

Código	alt. (mm)	larg. (mm)
FR0001A	550	2220
FR0001B	550	2320
FR0001C	550	2420
FR0001D	550	2960
FR0001E	600	2220
FR0001F	600	2320
FR0001G	600	2420

Código	alt. (mm)	larg. (mm)
FR0001H	600	2960
FR0001I	650	2220
FR0001J	650	2320
FR0001K	650	2420
FR0001L	650	2960
FR0001M	700	2220
FR0001N	700	2320

Código	alt. (mm)	larg. (mm)
FR0001O	700	2420
FR0001P	700	2960
FR0001Q	800	2220
FR0001R	800	2320
FR0001S	800	2420
FR0001T	800	2960
FR0001U	900	2220

Código	alt. (mm)	larg. (mm)
FR0001V	900	2320
FR0001X	900	2420
FR0001Z	900	2960
FR0001AA	1000	2220
FR0001AB	1000	2320
FR0001AC	1000	2420
FR0001AD	1000	2960

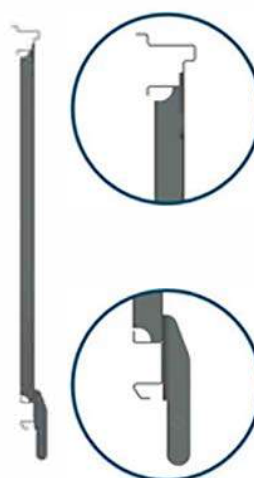
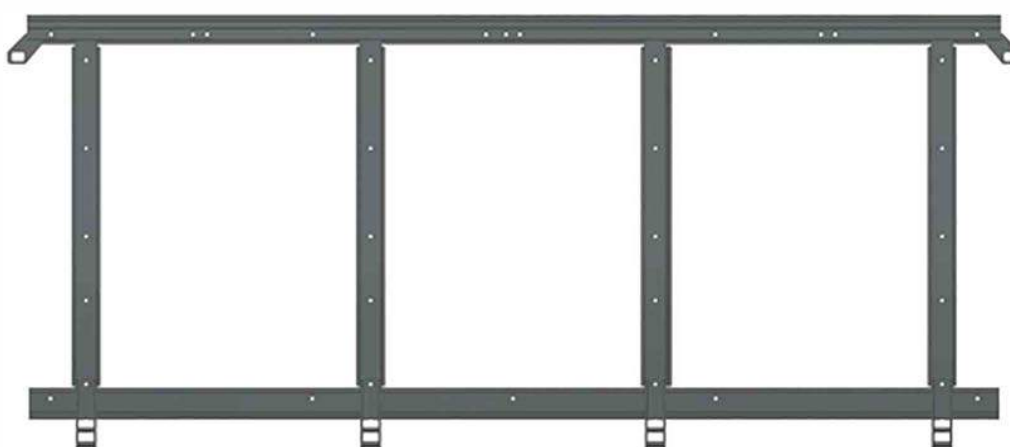

GRADE LATERAL SUPERIOR

Código	alt. (mm)	larg. (mm)
FR0003A	550	2230
FR0003B	550	2330
FR0003C	550	2430
FR0003D	550	2970
FR0003E	600	2230
FR0003F	600	2330
FR0003G	600	2430

Código	alt. (mm)	larg. (mm)
FR0003H	600	2970
FR0003I	650	2230
FR0003J	650	2330
FR0003K	650	2430
FR0003L	650	2970
FR0003M	700	2230
FR0003N	700	2330

Código	alt. (mm)	larg. (mm)
FR0003O	700	2430
FR0003P	700	2970
FR0003Q	800	2230
FR0003R	800	2330
FR0003S	800	2430
FR0003T	800	2970
FR0003U	900	2230

Código	alt. (mm)	larg. (mm)
FR0003V	900	2330
FR0003X	900	2430
FR0003Z	900	2970
FR0003AA	1000	2230
FR0003AB	1000	2330
FR0003AC	1000	2430
FR0003AD	1000	2970



COMPATÍVEL COM LINHA

RANDON

LINHA CARRETAS NOVAS

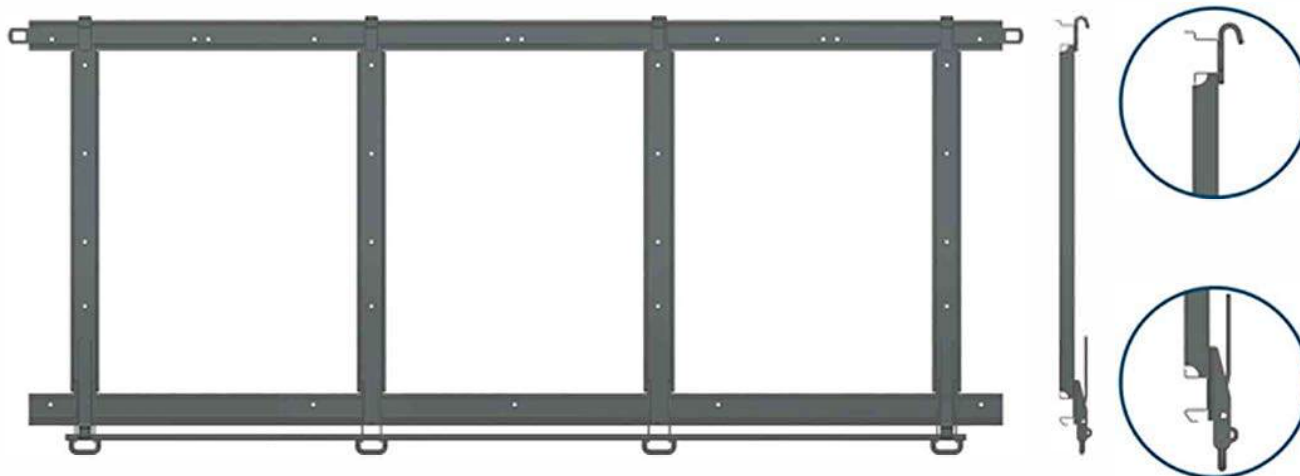

GRADE TRASEIRA INFERIOR

Código	alt. (mm)	larg. (mm)	Código	alt. (mm)	larg. (mm)
FR0004A	550	2420	FR0004E	800	2420
FR0004B	600	2420	FR0004F	900	2420
FR0004C	650	2420	FR0004C	1000	2420
FR0004D	700	2420			

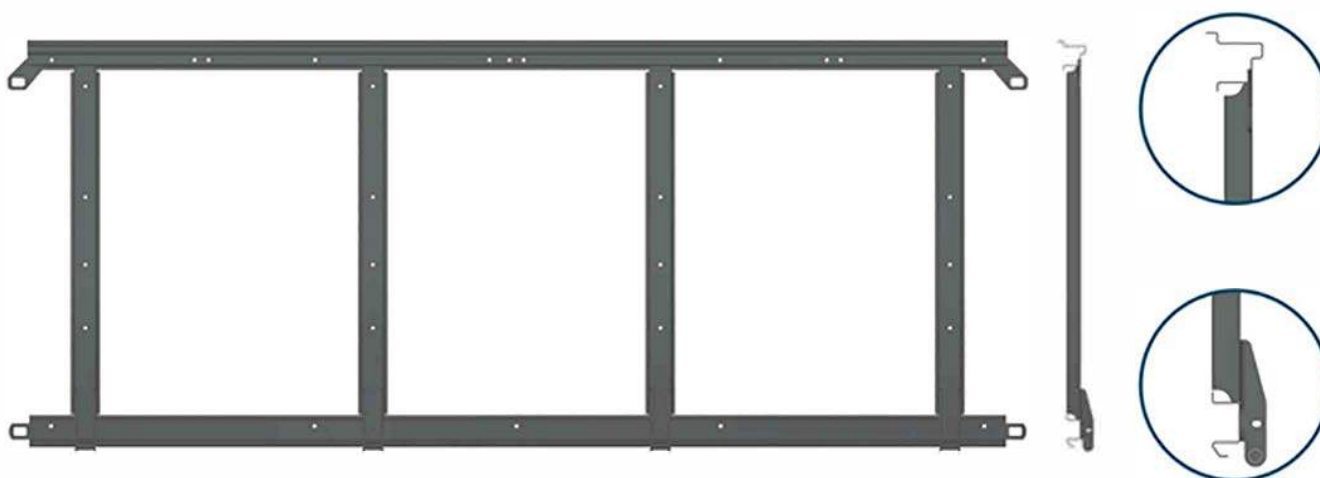

GRADE TRASEIRA SUPERIOR

Código	alt. (mm)	larg. (mm)	Código	alt. (mm)	larg. (mm)
FR0006A	550	2430	FR0006E	800	2430
FR0006B	600	2430	FR0006F	900	2430
FR0006C	650	2430	FR0006C	1000	2430
FR0006D	700	2430			

COMPATÍVEL COM LINHA

RANDON



LANÇAMENTOS

LINHA CARRETAS ECOPLATE 2

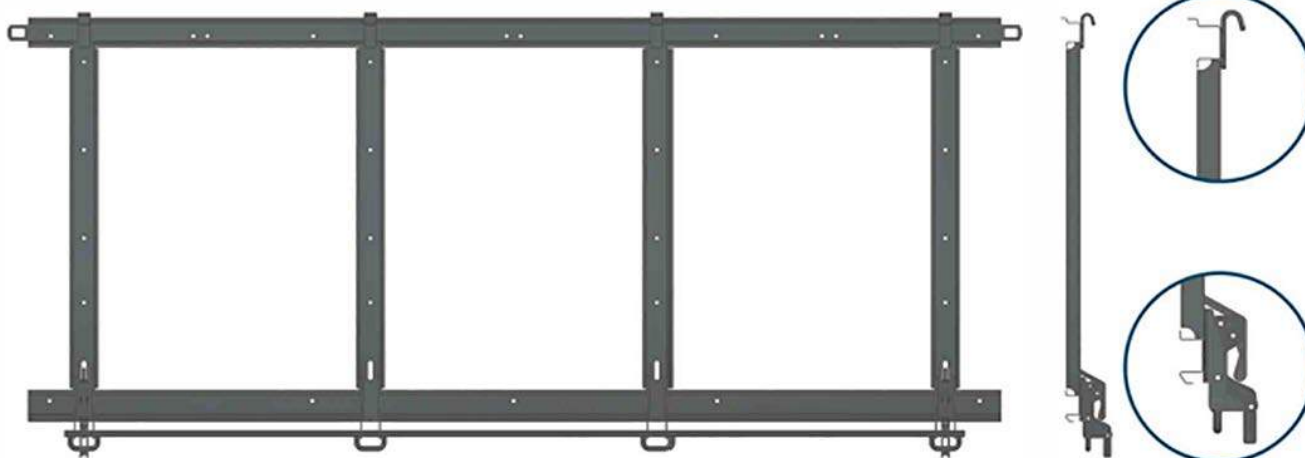

GRADE TRASEIRA INFERIOR

Código	alt. (mm)	larg. (mm)	Código	alt. (mm)	larg. (mm)
FR0007A	550	2420	FR0007E	800	2420
FR0007B	600	2420	FR0007F	900	2420
FR0007C	650	2420	FR0007C	1000	2420
FR0007D	700	2420			



COLUNA GRADE TRASEIRA INFERIOR

Código	comp. (mm)	Código	comp. (mm)
FR0030AA	430	FR0030EA	680
FR0030BA	480	FR0030FA	780
FR0030CA	530	FR0030GA	880
FR0030DA	580		



FR0015A
GANCHO TOMBADOR



FR0010A
CONJUNTO TOMBADOR
"COMPLETO"



FR0010B
CONJUNTO TOMBADOR
"SEM O GANCHO"

LANÇAMENTOS

LINHA CARRETAS ECOPLATE 3



GRADE LATERAL INFERIOR

Código	alt. (mm)	larg. (mm)
FR0008A	550	2220
FR0008B	550	2320
FR0008C	550	2420
FR0008D	550	2960
FR0008E	600	2220
FR0008F	600	2320
FR0008G	600	2420

Código	alt. (mm)	larg. (mm)
FR0008H	600	2960
FR0008I	650	2220
FR0008J	650	2320
FR0008K	650	2420
FR0008L	650	2960
FR0008M	700	2220
FR0008N	700	2320

Código	alt. (mm)	larg. (mm)
FR0008O	700	2420
FR0008P	700	2960
FR0008Q	800	2220
FR0008R	800	2320
FR0008S	800	2420
FR0008T	800	2960
FR0008U	900	2220

Código	alt. (mm)	larg. (mm)
FR0008V	900	2320
FR0008X	900	2420
FR0008Z	900	2960
FR0008AA	1000	2220
FR0008AB	1000	2320
FR0008AC	1000	2420
FR0008AD	1000	2960

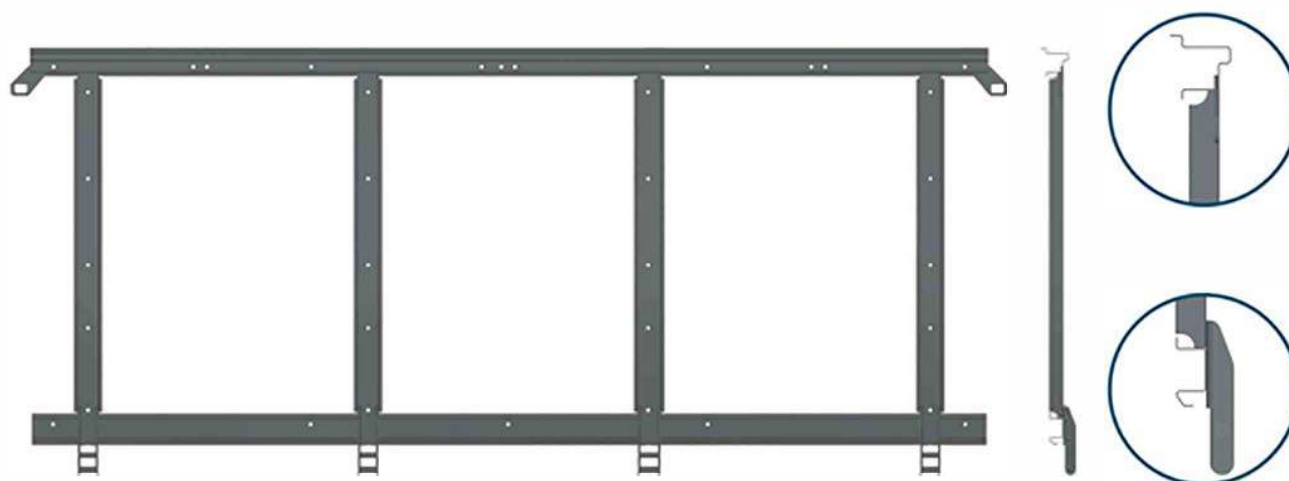

GRADE LATERAL SUPERIOR

Código	alt. (mm)	larg. (mm)
FR0009A	550	2230
FR0009B	550	2330
FR0009C	550	2430
FR0009D	550	2970
FR0009E	600	2230
FR0009F	600	2330
FR0009G	600	2430

Código	alt. (mm)	larg. (mm)
FR0009H	600	2970
FR0009I	650	2230
FR0009J	650	2330
FR0009K	650	2430
FR0009L	650	2970
FR0009M	700	2230
FR0009N	700	2330

Código	alt. (mm)	larg. (mm)
FR0009O	700	2430
FR0009P	700	2970
FR0009Q	800	2230
FR0009R	800	2330
FR0009S	800	2430
FR0009T	800	2970
FR0009U	900	2230

Código	alt. (mm)	larg. (mm)
FR0009V	900	2330
FR0009X	900	2430
FR0009Z	900	2970
FR0009AA	1000	2230
FR0009AB	1000	2330
FR0009AC	1000	2430
FR0009AD	1000	2970

COMPATÍVEL COM LINHA

RANDON



LANÇAMENTOS

LINHA CARRETAS ECOPLATE 3



GRADE TRASEIRA INFERIOR

Código	alt. (mm)	larg. (mm)	Código	alt. (mm)	larg. (mm)
FR0013A	550	2420	FR0013E	800	2420
FR0013B	600	2420	FR0013F	900	2420
FR0013C	650	2420	FR0013G	1000	2420
FR0013D	700	2420			



GRADE TRASEIRA SUPERIOR

Código	alt. (mm)	larg. (mm)	Código	alt. (mm)	larg. (mm)
FR0018A	550	2430	FR0018E	800	2430
FR0018B	600	2430	FR0018F	900	2430
FR0018C	650	2430	FR0018C	1000	2430
FR0018D	700	2430			

LINHA FUEIROS LARGOS NOVOS



FUEIRO LATERAL INFERIOR

Código	alt. (mm)	larg. (mm)
FR0109A	550	145
FR0109B	600	145
FR0109C	650	145
FR0109D	700	145
FR0109E	800	145
FR0109F	900	145
FR0109G	1000	145



FUEIRO LATERAL SUPERIOR

Código	alt. (mm)	larg. (mm)
FR0110A	550	145
FR0110B	600	145
FR0110C	650	145
FR0110D	700	145
FR0110E	800	145
FR0110F	900	145
FR0110G	1000	145



FUEIRO DE CANTO INFERIOR DIREITO

Código	alt. (mm)	larg. (mm)
FR0111A	550	145
FR0111B	600	145
FR0111C	650	145
FR0111D	700	145
FR0111E	800	145
FR0111F	900	145
FR0111G	1000	145



FUEIRO DE CANTO INFERIOR ESQUERDO

Código	alt. (mm)	larg. (mm)
FR0112A	550	145
FR0112B	600	145
FR0112C	650	145
FR0112D	700	145
FR0112E	800	145
FR0112F	900	145
FR0112G	1000	145



FUEIRO DE CANTO SUPERIOR DIREITO

Código	alt. (mm)	larg. (mm)
FR0113A	550	145
FR0113B	600	145
FR0113C	650	145
FR0113D	700	145
FR0113E	800	145
FR0113F	900	145
FR0113G	1000	145



FUEIRO DE CANTO SUPERIOR ESQUERDO

Código	alt. (mm)	larg. (mm)
FR0114A	550	145
FR0114B	600	145
FR0114C	650	145
FR0114D	700	145
FR0114E	800	145
FR0114F	900	145
FR0114G	1000	145

COMPATÍVEL COM LINHA

RANDON



LINHA FUEIROS NOVOS



FUEIRO LATERAL INFERIOR

Código	alt. (mm)	larg. (mm)
FR0115A	550	95
FR0115B	600	95
FR0115C	650	95
FR0115D	700	95
FR0115E	800	95
FR0115F	900	95
FR0115G	1000	95



FUEIRO LATERAL SUPERIOR

Código	alt. (mm)	larg. (mm)
FR0116A	550	95
FR0116B	600	95
FR0116C	650	95
FR0116D	700	95
FR0116E	800	95
FR0116F	900	95
FR0116G	1000	95



FUEIRO DE CANTO INFERIOR DIREITO

Código	alt. (mm)	larg. (mm)
FR0117A	550	95
FR0117B	600	95
FR0117C	650	95
FR0117D	700	95
FR0117E	800	95
FR0117F	900	95
FR0117G	1000	95



FUEIRO DE CANTO INFERIOR ESQUERDO

Código	alt. (mm)	larg. (mm)
FR0118A	550	95
FR0118B	600	95
FR0118C	650	95
FR0118D	700	95
FR0118E	800	95
FR0118F	900	95
FR0118G	1000	95



FUEIRO DE CANTO SUPERIOR DIREITO

Código	alt. (mm)	larg. (mm)
FR0119A	550	95
FR0119B	600	95
FR0119C	650	95
FR0119D	700	95
FR0119E	800	95
FR0119F	900	95
FR0119G	1000	95



FUEIRO DE CANTO SUPERIOR ESQUERDO

Código	alt. (mm)	larg. (mm)
FR0120A	550	95
FR0120B	600	95
FR0120C	650	95
FR0120D	700	95
FR0120E	800	95
FR0120F	900	95
FR0120G	1000	95



COMPATÍVEL COM LINHA

RANDON

LINHA FRONTAIS BRASILIS

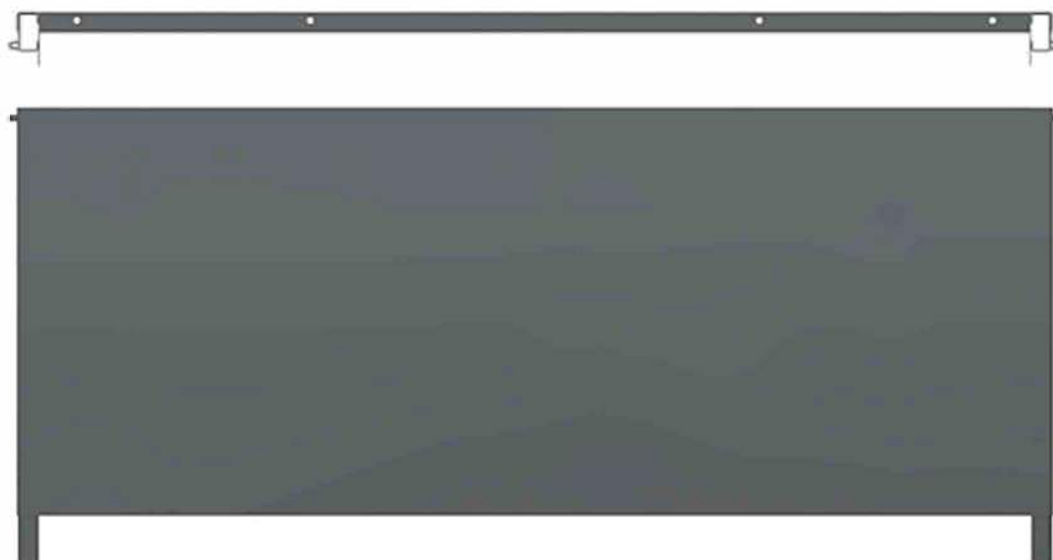

FRONTAL INFERIOR

Código	alt. (mm)	Código	alt. (mm)
FR0300A	550	FR0300E	800
FR0300B	600	FR0300F	900
FR0300C	650	FR0300G	1000
FR0300D	700		

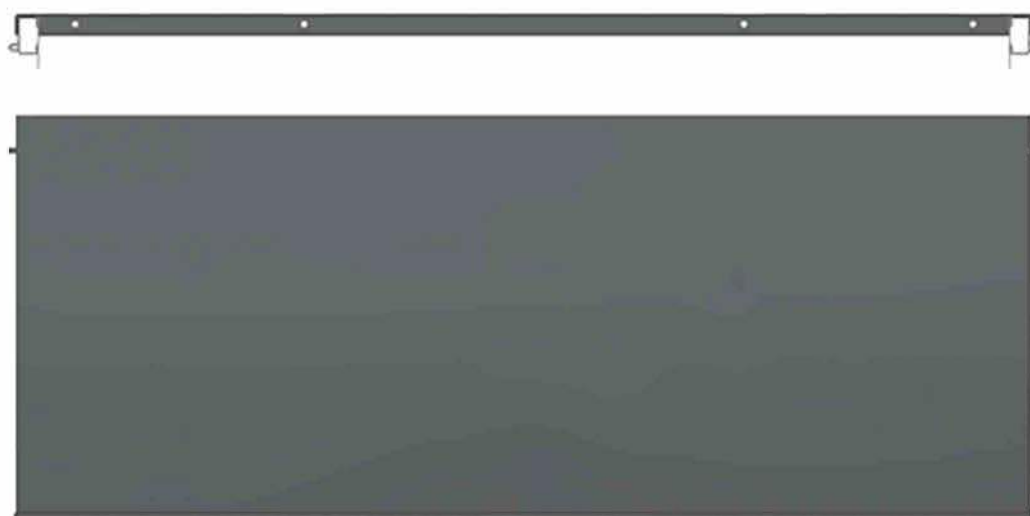

FRONTAL SUPERIOR

Código	alt. (mm)	Código	alt. (mm)
FR0303A	550	FR0303E	800
FR0303B	600	FR0303F	900
FR0303C	650	FR0303G	1000
FR0303D	700		

COMPATÍVEL COM LINHA

RANDON



LINHA FRONTAIS 2018 RETOS

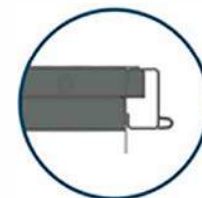
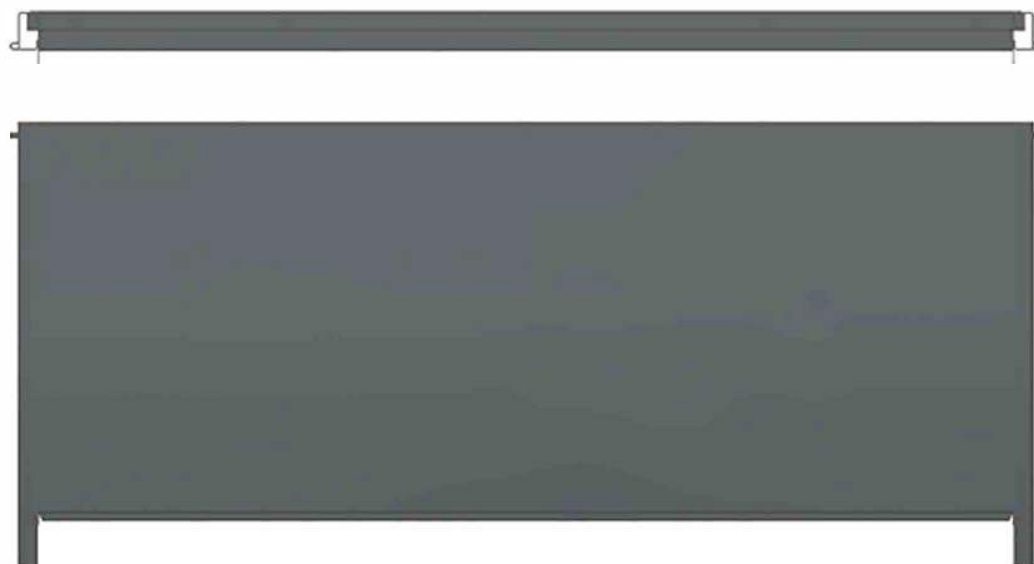

FRONTAL INFERIOR

Código	alt. (mm)	Código	alt. (mm)
FR0304A	550	FR0304E	800
FR0304B	600	FR0304F	900
FR0304C	650	FR0304G	1000
FR0304D	700		

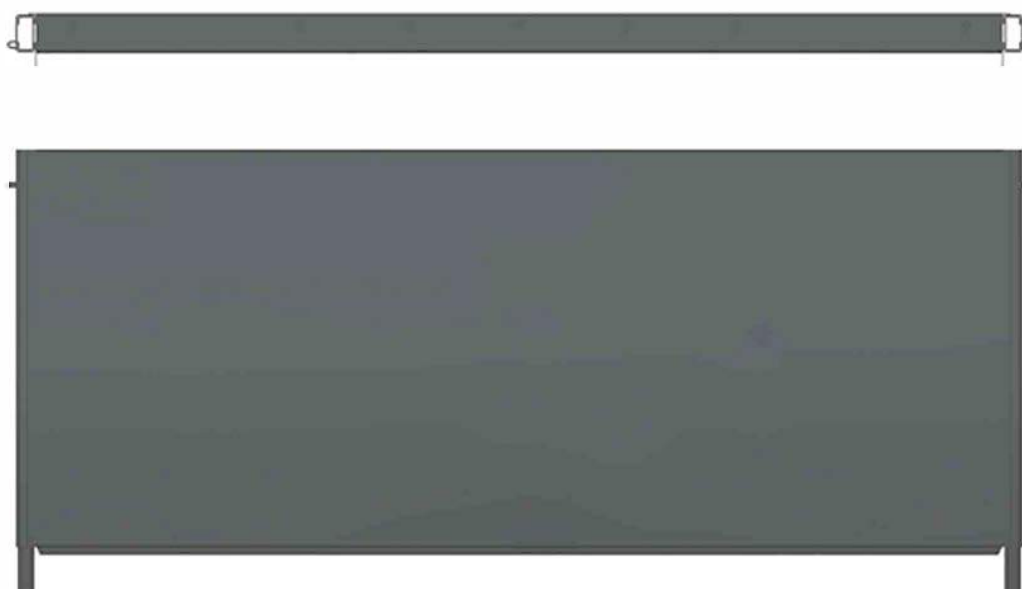

FRONTAL SUPERIOR

Código	alt. (mm)	Código	alt. (mm)
FR0305A	550	FR0305E	800
FR0305B	600	FR0305F	900
FR0305C	650	FR0305G	1000
FR0305D	700		



COMPATÍVEL COM LINHA

RANDON

LINHA FRONTAIS CURVOS

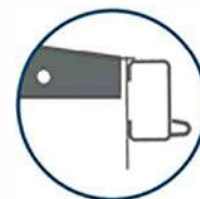
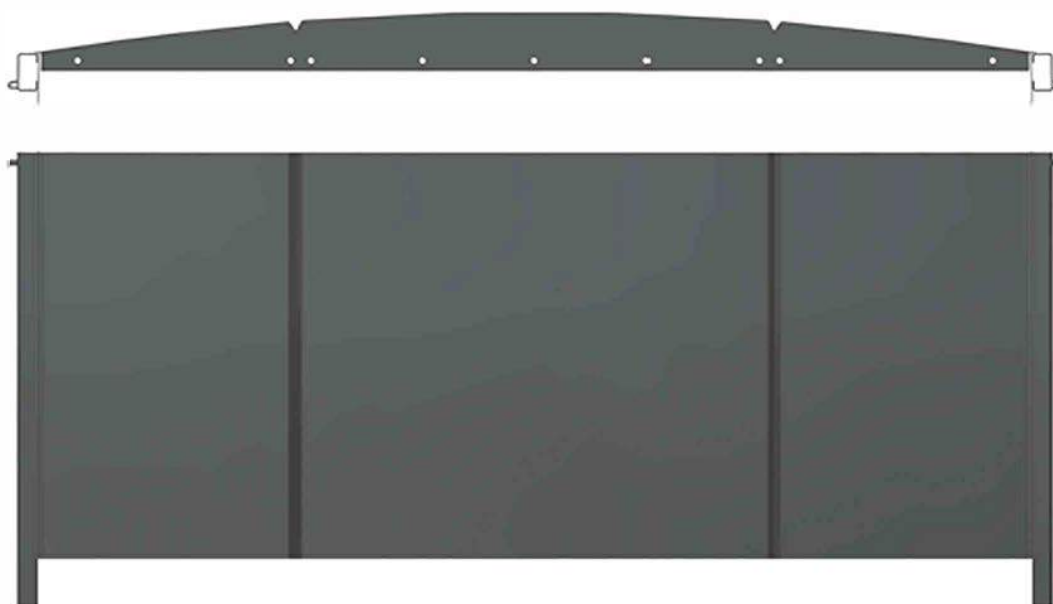

FRONTAL INFERIOR

Código	alt. (mm)	Código	alt. (mm)
FR0306A	550	FR0306E	800
FR0306B	600	FR0306F	900
FR0306C	650	FR0306G	1000
FR0306D	700		

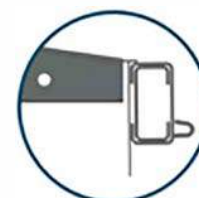
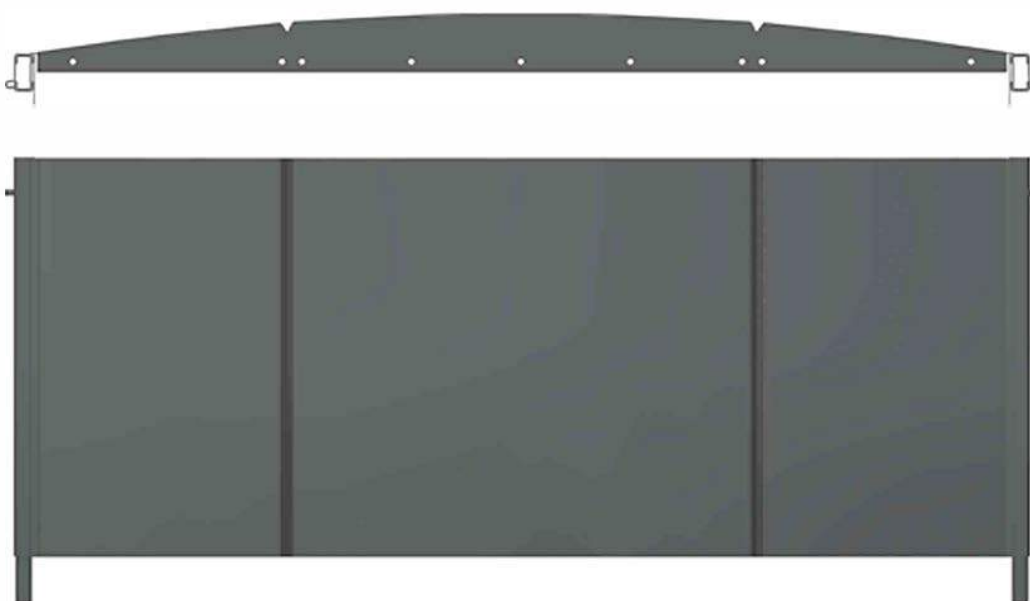

FRONTAL SUPERIOR

Código	alt. (mm)	Código	alt. (mm)
FR0307A	550	FR0307E	800
FR0307B	600	FR0307F	900
FR0307C	650	FR0307G	1000
FR0307D	700		

COMPATÍVEL COM LINHA

RANDON



COLUNAS

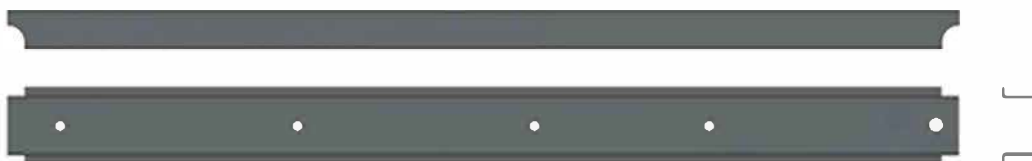

COLUNA INFERIOR E SUPERIOR

Código	comp. (mm)	Código	comp. (mm)
FR0027AA	430	FR0027EA	680
FR0027BA	480	FR0027FA	780
FR0027CA	530	FR0027GA	880
FR0027DA	580		



COLUNA SUPERIOR

Código	comp. (mm)	Código	comp. (mm)
FR0033AA	450	FR0033EA	700
FR0033BA	500	FR0033FA	800
FR0033CA	550	FR0033GA	900
FR0033DA	600		



COLUNA INFERIOR

Código	comp. (mm)	Código	comp. (mm)
FR0035AA	450	FR0035EA	700
FR0035BA	500	FR0035FA	800
FR0035CA	550	FR0035GA	900
FR0035DA	600		



COLUNA GRADE TRASEIRA INFERIOR ECOPLATE 2 E ECOPLATE 3

Código	comp. (mm)	Código	comp. (mm)
FR0030AA	430	FR0030EA	680
FR0030BA	480	FR0030FA	780
FR0030CA	530	FR0030GA	880
FR0030DA	580		





COMPATÍVEL COM LINHA

RANDON

COLUNAS



COLUNA GRADE LATERAL COM DOBRADIÇA

Código	comp. (mm)	Código	comp. (mm)
FR0028AA	430	FR0028EA	680
FR0028BA	4800	FR0028FA	780
FR0028CA	530	FR0028GA	880
FR0028DA	580		

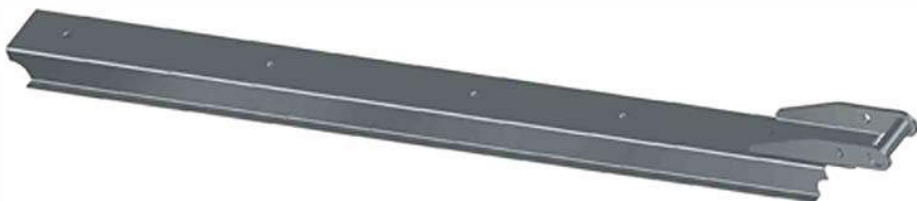

COLUNA GRADE TRASEIRA SUP. COM DOBRADIÇA

Código	comp. (mm)	Código	comp. (mm)
FR0029AA	430	FR0029EA	680
FR0029BA	480	FR0029FA	780
FR0029CA	530	FR0029GA	880
FR0029DA	580		



FR0010 CONJUNTO TAMPA TRASEIRA INFERIOR



FR0010A CONJUNTO TOMBADOR ECOPLATE 2 - ECOPLATE 3 "COMPLETO"

FR0010B CONJUNTO TOMBADOR ECOPLATE 2 - ECOPLATE 3 "SEM O GANCHO"



COMPATÍVEL COM LINHA

RANDON



DIVERSOS

VIGUETA INFERIOR P/ TAMPA INFERIOR E SUPERIOR

Código	comp. (mm)
FR0038A	2220
FR0038B	2320
FR0038C	2420
FR0038D	2960



VIGUETA SUPERIOR P/ TAMPA INFERIOR E SUPERIOR

Código	comp. (mm)
FR0040A	2220
FR0040B	2320
FR0040C	2420
FR0040D	2960



VIGUETA SUPERIOR P/ TAMPA SUPERIOR C/ FURAÇÃO DO ARCO

Código	comp. (mm)
FR0043A	2230
FR0043B	2330
FR0043C	2430
FR0043D	2970



LANÇAMENTOS

VIGUETAS LINHA ECOPLATE 3

VIGUETA SUPERIOR P/TAMPA INFERIOR E SUPERIOR ECOPLATE 3

Código	comp. (mm)
FR0036A	2220
FR0036B	2320
FR0036C	2420
FR0036D	2960



VIGUETA SUPERIOR P/TAMPA SUPERIOR C/ FURAÇÃO DO ARCO ECOPLATE 3

Código	comp. (mm)
FR0037A	2230
FR0037B	2330
FR0037C	2430
FR0037D	2970



DIVERSOS

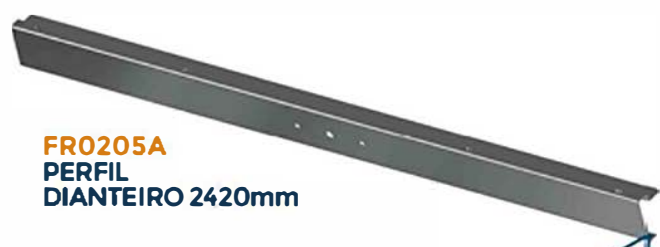

FR0205A
PERFIL
DIANTEIRO 2420mm

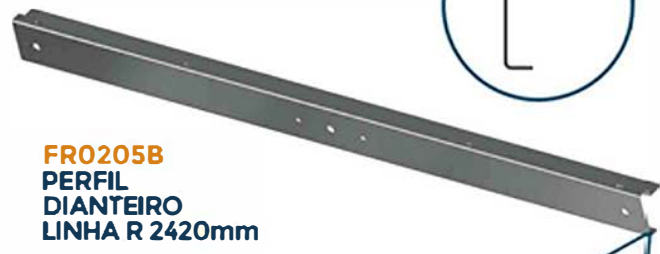

FR0205B
PERFIL
DIANTEIRO
LINHA R 2420mm

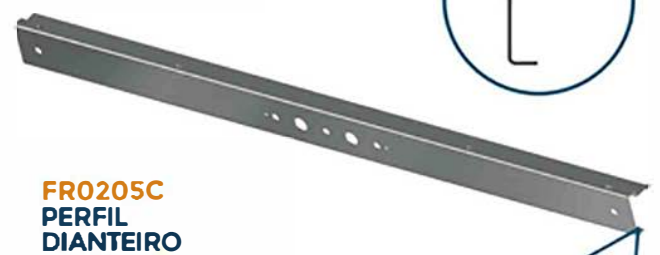

FR0205C
PERFIL
DIANTEIRO
LINHA R COM
SAÍDA ABS 2420mm

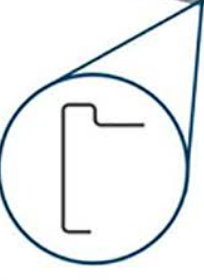

FR0206A
PERFIL LATERAL
PARA ASSOALHO
DE FERRO 2225mm

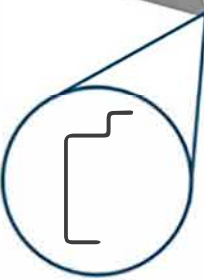

FR0206B
PERFIL LATERAL
PARA ASSOALHO
DE FERRO 2325mm



FR0206C
PERFIL LATERAL
PARA ASSOALHO
DE FERRO 2425mm



FR0206D
PERFIL LATERAL
PARA ASSOALHO
DE FERRO 2965mm

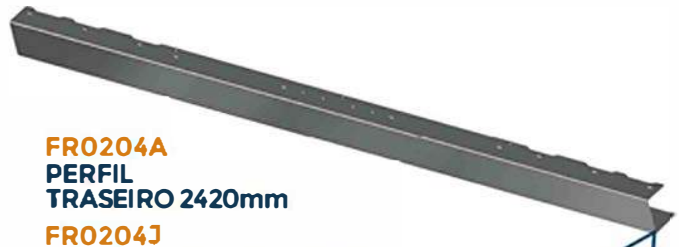

FR0204A
PERFIL
TRASEIRO 2420mm



FR0204J
PERFIL TRASEIRO 2420mm
REFORÇADO (esp. 6,35mm)



FR0204
PERFIL
TRASEIRO C/ FURAÇÃO
LINHA R 2420mm

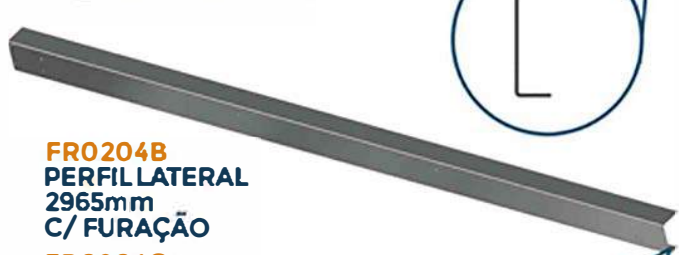
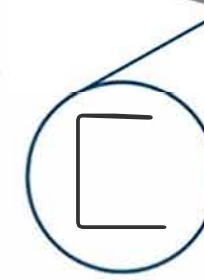

FR0204K
PERFIL TRASEIRO C/ FURAÇÃO
LINHA R 2420mm
REFORÇADO (esp. 6,35mm)



FR0204F
PERFIL
LATERAL
2965mm



FR0204H
PERFIL
LATERAL
2325mm



FR0204C
PERFIL
LATERAL
2425mm

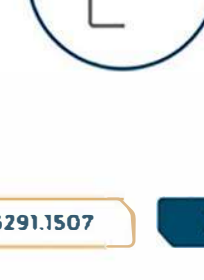

FR0204I
PERFIL
LATERAL
2225mm

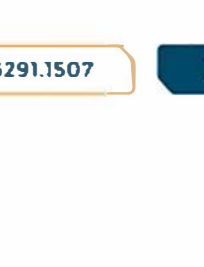

FR0204B
PERFIL LATERAL
2965mm
C/ FURAÇÃO



FR0204C
PERFIL LATERAL
2425mm
C/ FURAÇÃO



FR0204D
PERFIL LATERAL
2325mm
C/ FURAÇÃO



FR0204E
PERFIL LATERAL
2225mm
C/ FURAÇÃO



COMPATÍVEL COM LINHA

RANDON



DIVERSOS



FR0026A
DOBRADIÇA DA TAMPÁ
LATERAL RANDON ANTIGA



FR0026
DOBRADIÇA
DA TAMPÁ MODERNA



FR0017
DOBRADIÇA DO
TOMBADOR SUP.



FR0014
DOBRADIÇA DO
TOMBADOR INF.

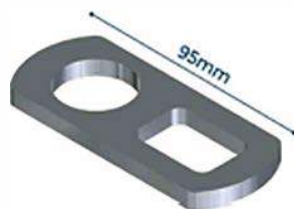

FR0019
ENGATE FÊMEA
95mm

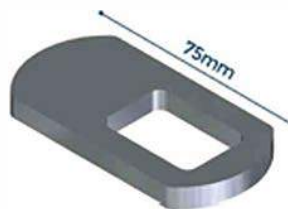

FR0020
ENGATE FÊMEA
75mm

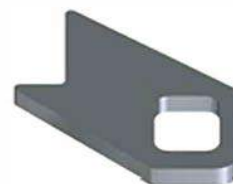

FR0022
ENGATE FÊMEA
MODERNO



FR0015
GANCHO
DO TOMBADOR



FR0016
DESLIZANTE
DO TOMBADOR



FR0011A
ENGATE RÁPIDO
TIPO "C"



F4029
ARANHA DE
ASSOALHO RANDON



FR0015A
GANCHO
TOMBADOR
ECOPLATE2



F4025
ENGATE FÊMEA
SUP. RANDON



FR0012
ENGATE RÁPIDO
TIPO "J"



F4058
ENGATE RÁPIDO
TIPO "C" FERRO
FUNDIDO



COMPATÍVEL COM LINHA

RANDON

DIVERSOS

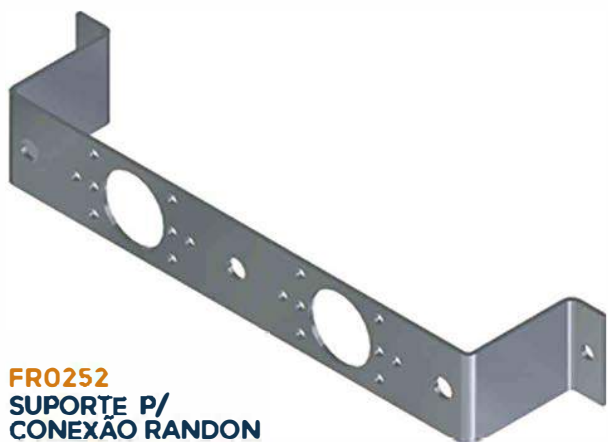

FR0252
SUPORTE P/
CONEXÃO RANDON



FR0250
SUPORTE CENTRAL DA
SAIA RANDON 900mm

FR0250A
SUPORTE CENTRAL DA
SAIA RANDON 800mm



FR0251
SUPORTE PLACA RANDON



F4200A
TAMPA BOCA
GRANELEIRA RANDON



F4200
CONJUNTO BOCA
GRANELEIRA RANDON



F4201A
BOCA DE GRANELEIRA
RANDON MODERNA
S/ REBAIXE (NYLON)



F4201
BOCA DE GRANELEIRA
RANDON (NYLON)



FR0115T
TAMPA DO FUEIRO
RANDON (PLÁSTICA)



FR0109T
TAMPA DO FUEIRO LARGO
RANDON (PLÁSTICA)



FR0038T
TAMPA DA VINQUETA
RANDON (PLÁSTICA)



FR4069
APOIO DA VINQUETA
RANDON (PLÁSTICA)

COMPATÍVEL COM LINHA

RANDON



LANÇAMENTOS
DIVERSOS



FR0260
SUPORTE PÉ DE APOIO
RANDON 330mm



FR0261
SUPORTE PÉ DE APOIO
RANDON 265mm



**RÉGUA
PARABARRO**

FR0240	590mm
FR0240A	640mm
FR0240B	670mm
FR0240C	690mm

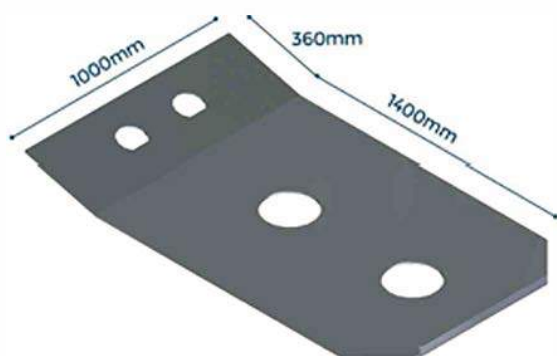

FR0600
MESA PINO REI
DA CARRETA RANDON
CHAPA 7,94mm

FR0600A
MESA PINO REI
DA CARRETA RANDON
CHAPA 9,54mm

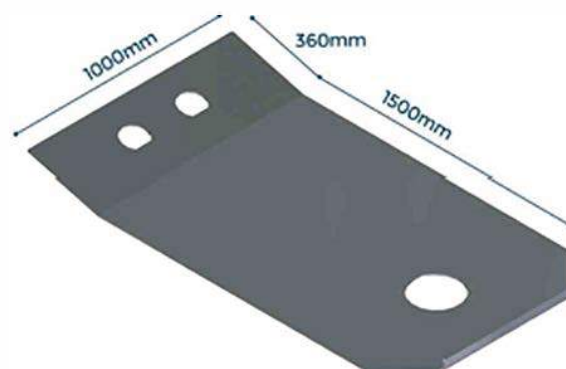

FR0601
MESA PINO REI
1º BITREM RANDON
CHAPA 7,94mm

FR0601A
MESA PINO REI
1º BITREM RANDON
CHAPA 9,54mm

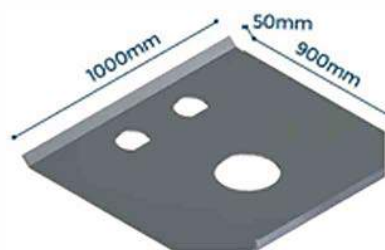

FR0602
MESA PINO REI
2º BITREM RANDON
CHAPA 7,94mm

FR0602A
MESA PINO REI
1º BITREM RANDON
CHAPA 9,54mm



COMPATÍVEL COM LINHA

RANDON

LANÇAMENTOS
DIVERSOS



FR0255
PLACA TRAS. RANDON
IDENTIFICAÇÃO DE MEDIDAS



TRAVESSA PASSANTE
MEDIDA ENTRE CHASSI 960mm

FR0400 2490mm
FR0400A 2530mm
FR0400B 2590mm



FR0230
SUPORTE SINALEIRA
BITREM 2460mm

TRAVESSA PASSANTE
MEDIDA ENTRE CHASSI 1055mm

FR0401 2530mm
FR0401A 2590mm

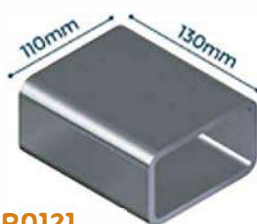

FR0121
CAIXA
DO FUEIRO

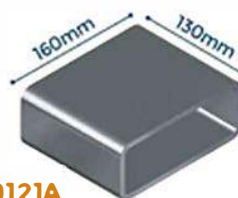

FR0121A
CAIXA DO
FUEIRO LARGO

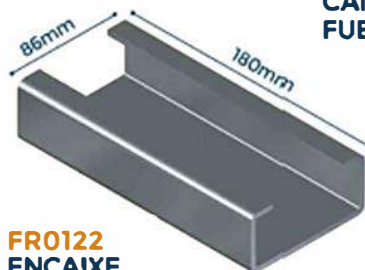

FR0122
ENCAIXE
DO FUEIRO

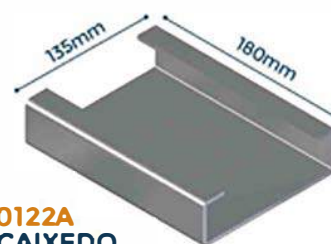

FR0122A
ENCAIXEDO
FUEIRO LARGO

COMPATÍVEL COM LINHA

RANDON



LANÇAMENTOS

linha **SIDER**

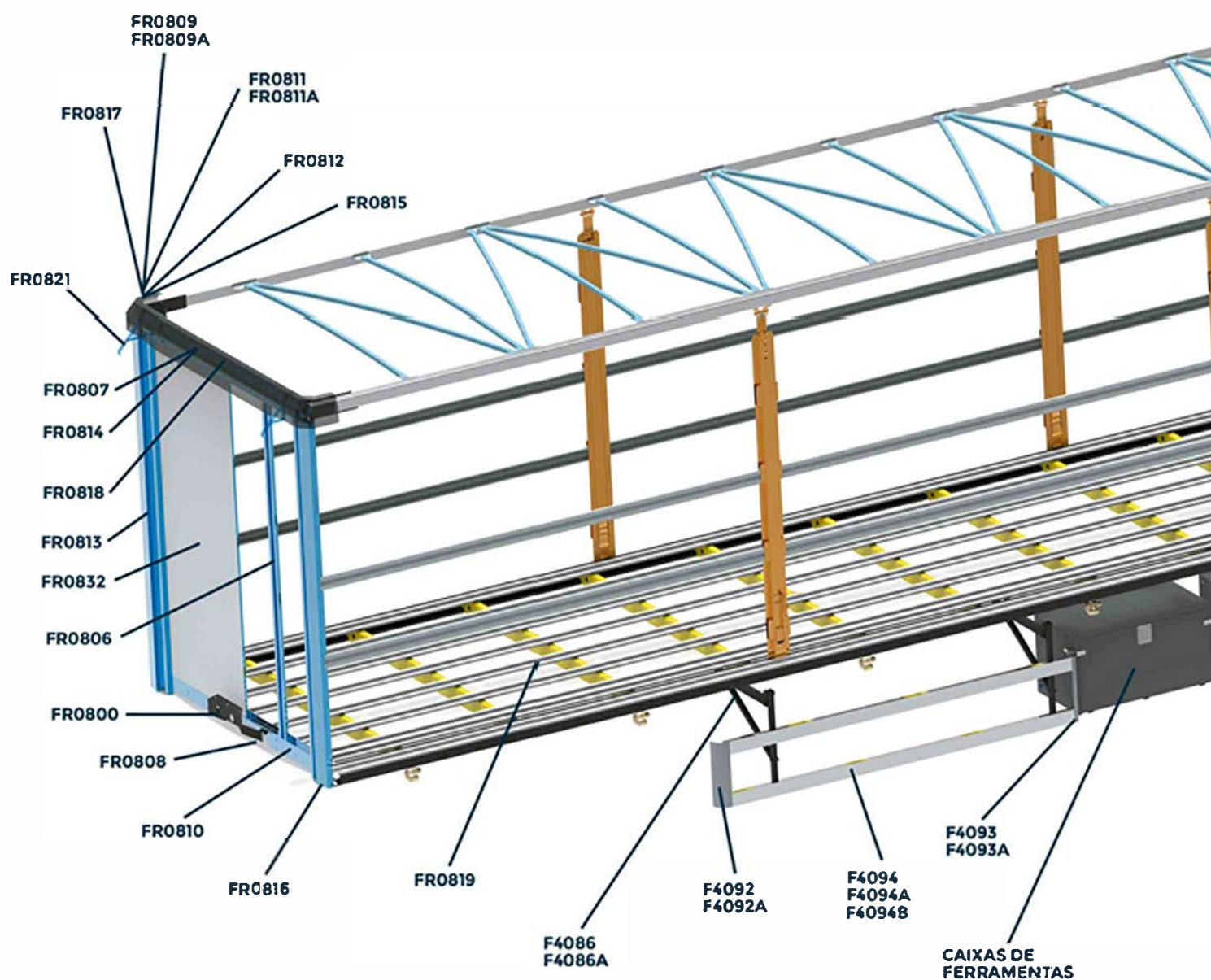



COMPATÍVEL COM LINHA

RANDON

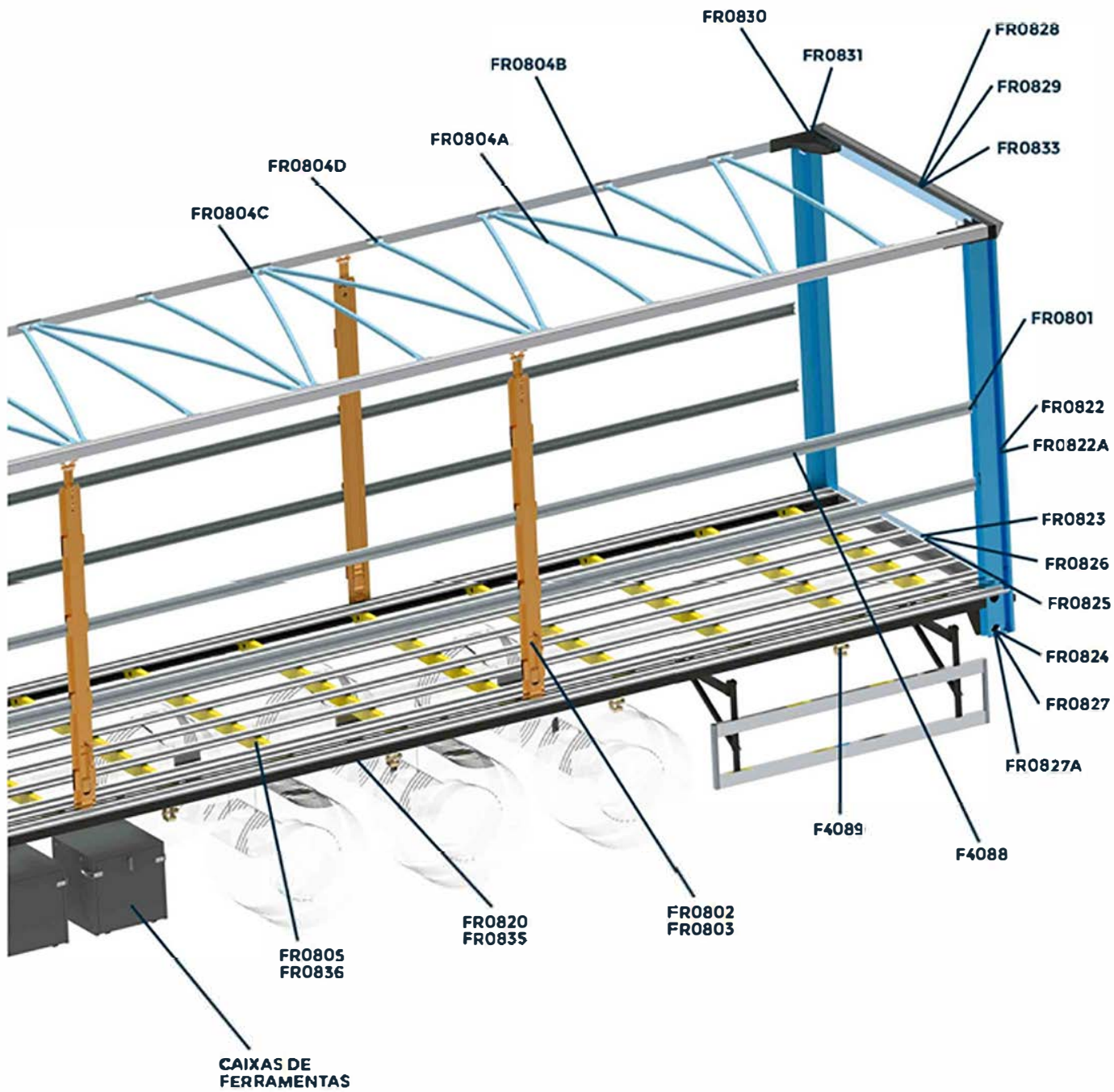

COMPATÍVEL COM LINHA

RANDON



LANÇAMENTOS

COMPATÍVEIS LINHA SIDER



FR0809
SUPORTE LATERAL LADO
DIREITO SUPERIOR DO
TRILHO SIDER RANDON

FR0809A
SUPORTE LATERAL LADO
ESQUERDO SUPERIOR DO
TRILHO SIDER RANDON



FR0811
SUPORTE DO TRILHO
SUPERIOR LADO DIREITO
FRONTAL E TRASEIRA
SIDER RANDON

FR0811A
SUPORTE DO TRILHO
SUPERIOR LADO ESQUERDO
FRONTAL E TRASEIRA
SIDER RANDON



FR0812
SUPORTE DO TRILHO
SUPERIOR LADO DIREITO
FRONTAL E TRASEIRA
SIDER RANDON

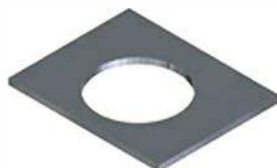

FR0817
GUIA TUBO SUPERIOR
LADO DIREITO/ESQUERDO
SIDER RANDON



FR0815
ACABAMENTO SUPERIOR
DE CANTO FRONTAL LADO
DIREITO/ESQUERDO
SIDER RANDON



FR0821
SUPORTE DESLIZA
FIO DO SIDER RANDON



FR0832
FOLHA DO
FRONTAL
SIDER RANDON



FR0800
SUPORTE
PARA CONEXÃO
SIDER RANDON

LANÇAMENTOS

COMPATÍVEIS LINHA SIDER



FR0818
REFORÇO SUPERIOR
FRONTAL LONA 2430mm
SIDER RANDON



FR0806
COLUNA CENTRAL
DO FRONTAL 2600mm
SIDER RANDON



FR0813
COLUNA FRONTAL LADO
DIREITO/ESQUERDO 2825mm
SIDER RANDON



FR0808
PERFIL DIANTEIRO
2525mm
SIDER RANDON



FR0810
REFORÇO INFERIOR
DO FRONTAL 2150mm
SIDER RANDON



FR0814
ACABAMENTO SUPERIOR
2150mm FRONTAL
SIDER RANDON



FR0816
REFORÇO INFERIOR DA COLUNA
FRONTAL LADO DIREITO/ESQUERDO
SIDER RANDON



FR0807
PERFIL SUPERIOR
FRONTAL 2160mm
SIDER RANDON

COMPATÍVEL COM LINHA

RANDON



LANÇAMENTOS

COMPATÍVEIS LINHA SIDER



FR0804A
ARCO DO SIDER 2540mm
RANDON

FR0804B
ARCO DO SIDER 2380mm
RANDON

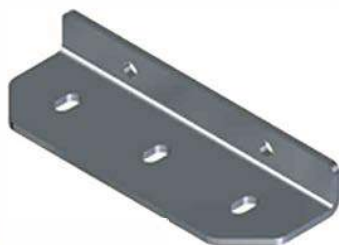

FR0804C
SUPORTE ARCO MAIOR
SIDER RANDON

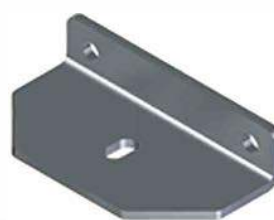

FR0804D
SUPORTE ARCO MENOR
SIDER RANDON



FR0819
PERFIL APOIO PARA
ASSOALHO 2990mm
SIDER RANDON



FR0805
TRAVESSA PASSANTE
DO SIDER RANDON
2585mm



FR0820
PERFIL LATERAL
2990mm
SIDER RANDON

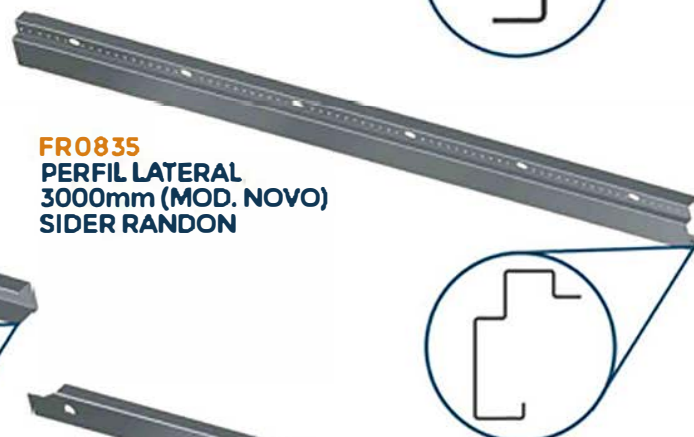

FR0835
PERFIL LATERAL
3000mm (MOD. NOVO)
SIDER RANDON



FR0836
TRAVESSA PASSANTE
SIDER RANDON (MOD. NOVO)
2585mm

LANÇAMENTOS

COMPATÍVEIS LINHA SIDER

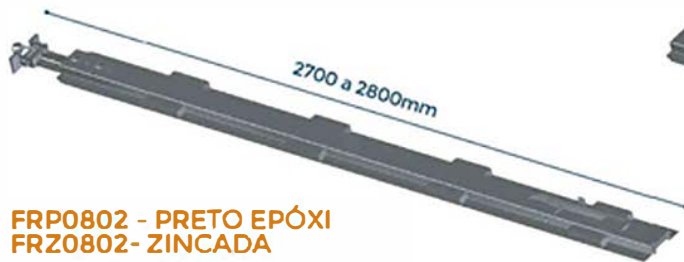

FRP0802 - PRETO EPÓXI
FRZ0802 - ZINCADA
CONJUNTO COLUNA
MÓVEL SIDER RANDON - MOD. 1



FRP0802C - PRETO EPÓXI
FRZ0802C - ZINCADA
COLUNA MÓVEL
SIDER RANDON - MOD. 1



FRP0802A - PRETO EPÓXI
FRZ0802A - ZINCADA
CABEÇA DA COLUNA
MÓVEL SIDER RANDON
MOD. 1



FRP0802B - PRETO EPÓXI
FRZ0802B - ZINCADA
PÉ DE APOIO DA COLUNA
MÓVEL SIDER RANDON
MOD. 1



FRP0801 - PRETO EPÓXI
FRZ0801 - ZINCADA
SUPORTE "U" DA COLUNA
MÓVEL SIDER RANDON

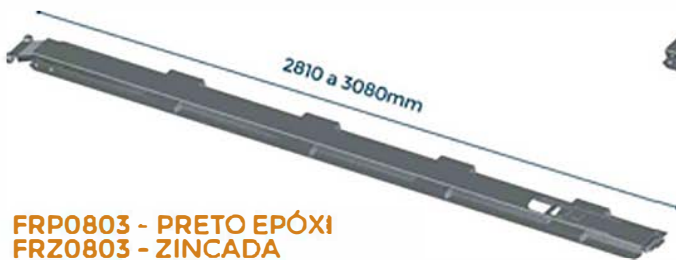

FRP0803 - PRETO EPÓXI
FRZ0803 - ZINCADA
CONJUNTO COLUNA
MÓVEL SIDER RANDON - MOD. 2



FRP0803C - PRETO EPÓXI
FRZ0803C - ZINCADA
COLUNA MÓVEL
SIDER RANDON - MOD. 2

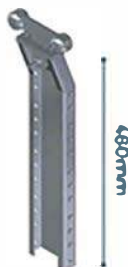

FRP0803A - PRETO EPÓXI
FRZ0803A - ZINCADA
CABEÇA DA COLUNA
MÓVEL SIDER RANDON
MOD. 2



FRP0803B - PRETO EPÓXI
FRZ0803B - ZINCADA
PÉ DE APOIO DA COLUNA
MÓVEL SIDER RANDON
MOD. 2



FR0834A
TRAVA DA COLUNA
SIDER RANDON

COMPATÍVEL COM LINHA

RANDON



LANÇAMENTOS

COMPATÍVEIS LINHA SIDER

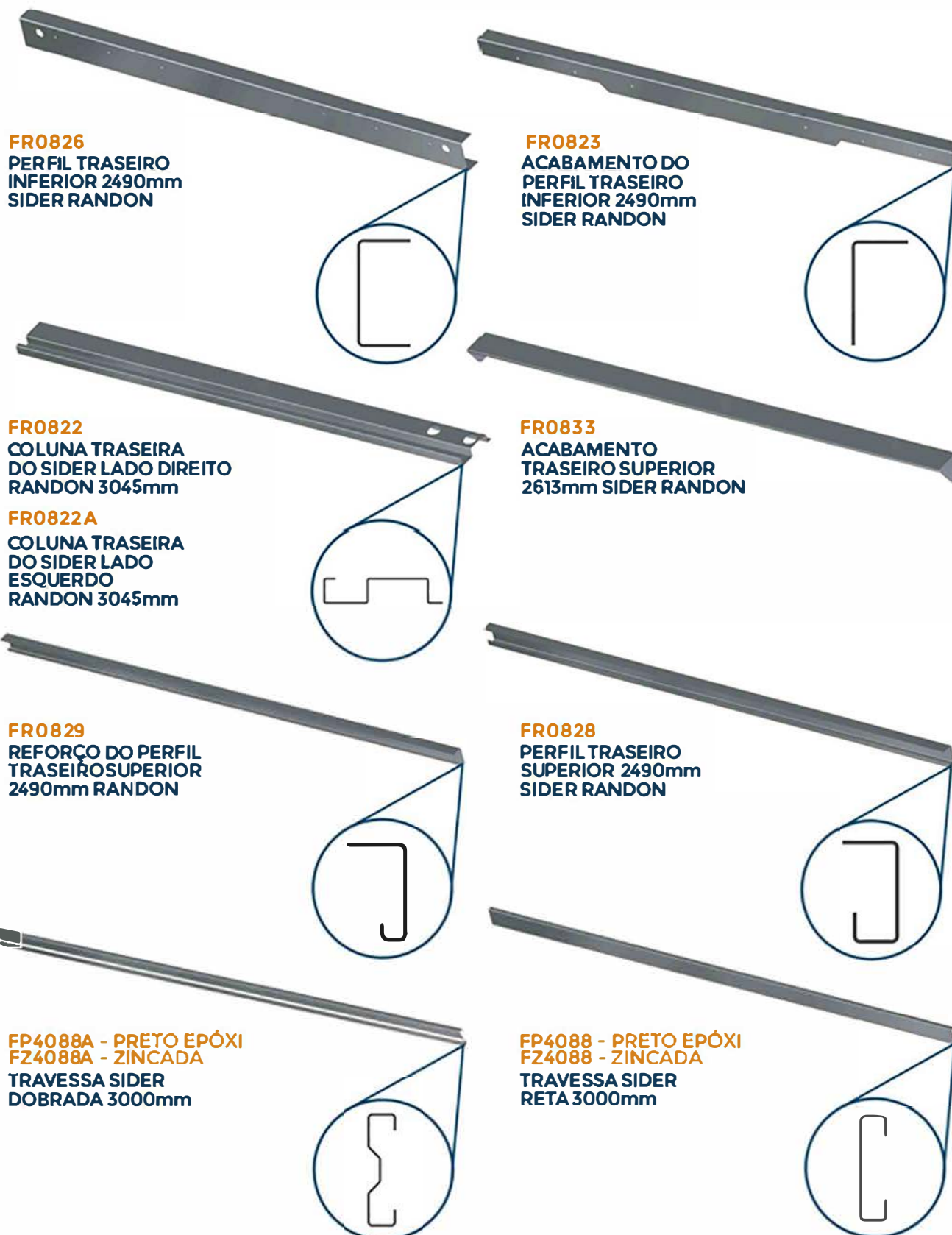

FR0826
PERFIL TRASEIRO
INFERIOR 2490mm
SIDER RANDON

FR0823
ACABAMENTO DO
PERFIL TRASEIRO
INFERIOR 2490mm
SIDER RANDON

FR0822
COLUNA TRASEIRA
DO SIDER LADO DIREITO
RANDON 3045mm

FR0833
ACABAMENTO
TRASEIRO SUPERIOR
2613mm SIDER RANDON

FR0822A
COLUNA TRASEIRA
DO SIDER LADO
ESQUERDO
RANDON 3045mm

FR0829
REFORÇO DO PERFIL
TRASEIRO SUPERIOR
2490mm RANDON

FR0828
PERFIL TRASEIRO
SUPERIOR 2490mm
SIDER RANDON

FP4088A - PRETO EPÓXI
FZ4088A - ZINCADA
TRAVESSA SIDER
DOBRADA 3000mm

FP4088 - PRETO EPÓXI
FZ4088 - ZINCADA
TRAVESSA SIDER
RETA 3000mm

Fabricamos medidas especiais
(consulte o representante da sua região ou fábrica)

LANÇAMENTOS

COMPATÍVEIS LINHA SIDER

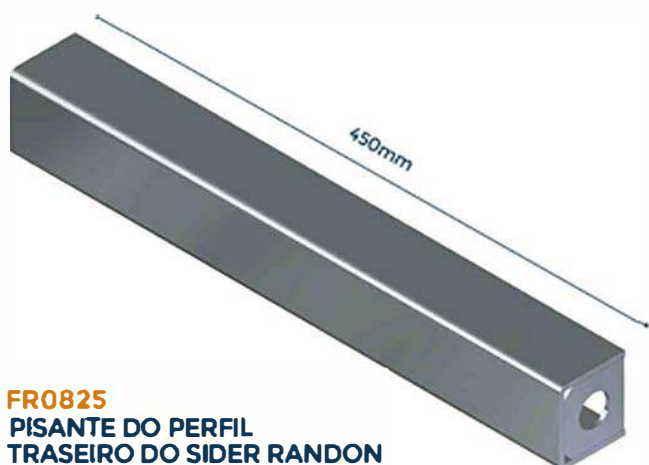

FR0825
PISANTE DO PERFIL
TRASEIRO DO SIDER RANDON



FR0827
REFORÇO INFERIOR
DO PERFIL TRASEIRO
LADO DIREITO RANDON

FR0827A
REFORÇO INFERIOR
DO PERFIL TRASEIRO
LADO ESQUERDO RANDON



FR0830
REFORÇO TRASEIRO
SUPERIOR DA COLUNA
SIDER RANDON



FR0824
REFORÇO DA COLUNA
TRASEIRA INFERIOR
DO SIDER RANDON



FR0831
REFORÇO TRASEIRO
SUPERIOR RETO
SIDER RANDON



F4089
CATRACA SIDER

- 100% ZINCADA
- EIXO TRACÇÃO INTEIRO



F4089E
CONJUNTO DE FIXAÇÃO
CATRACA SIDER
ACOMPANHA PARAFUSO

COMPATÍVEL COM LINHA

RANDON



LANÇAMENTOS

linha **DOLLY**



FR0253
SUPORTE SINALEIRA
TRASEIRA DO DOLLY
COMPLETA RANDON
LADO DIREITO



FR0253A
SUPORTE SINALEIRA
TRASEIRA DO DOLLY
COMPLETA RANDON
LADO ESQUERDO



FR0253B
SUPORTE PARA
FIXAÇÃO DA SINALEIRA
DO DOLLY RANDON
LADO DIREITO



FR0253D
SUPORTE PARA
FIXAÇÃO DO DOLLY
RANDON LADO ESQUERDO



FR0253C
SUPORTE DE FIXAÇÃO
PARA A SINALEIRA DO
DOLLY RANDON



FR0256
SUPORTE SINALEIRA
DIANTEIRA DO DOLLY
LADO DIREITO/LADO
ESQUERDO RANDON



COMPATÍVEL COM LINHA

RANDON

LANÇAMENTOS

linha **BASCULANTES**



FR0257
SUPORTE SINALEIRA DA
BASCULANTE RANDON



FR0259
SUPORTE SINALEIRA DA
BASCULANTE DIANTEIRO LD/LE
FR0259A
BASE DA SINALEIRA
FR0259B
BRAÇO DA SINALEIRA



FR0258
SUPORTE SINALEIRA
DA BASCULANTE RANDON
SOLDADA LADO DIREITO



FR0258A
SUPORTE SINALEIRA
DA BASCULANTE RANDON
SOLDADA LADO ESQUERDO



FR0900
DOBRADIÇA DA
BASCULANTE RANDON



FR0902
TRAVA TAMPA DA
BASCULANTE RANDON

PEÇAS COMPATÍVEIS COM

linha GUERRA

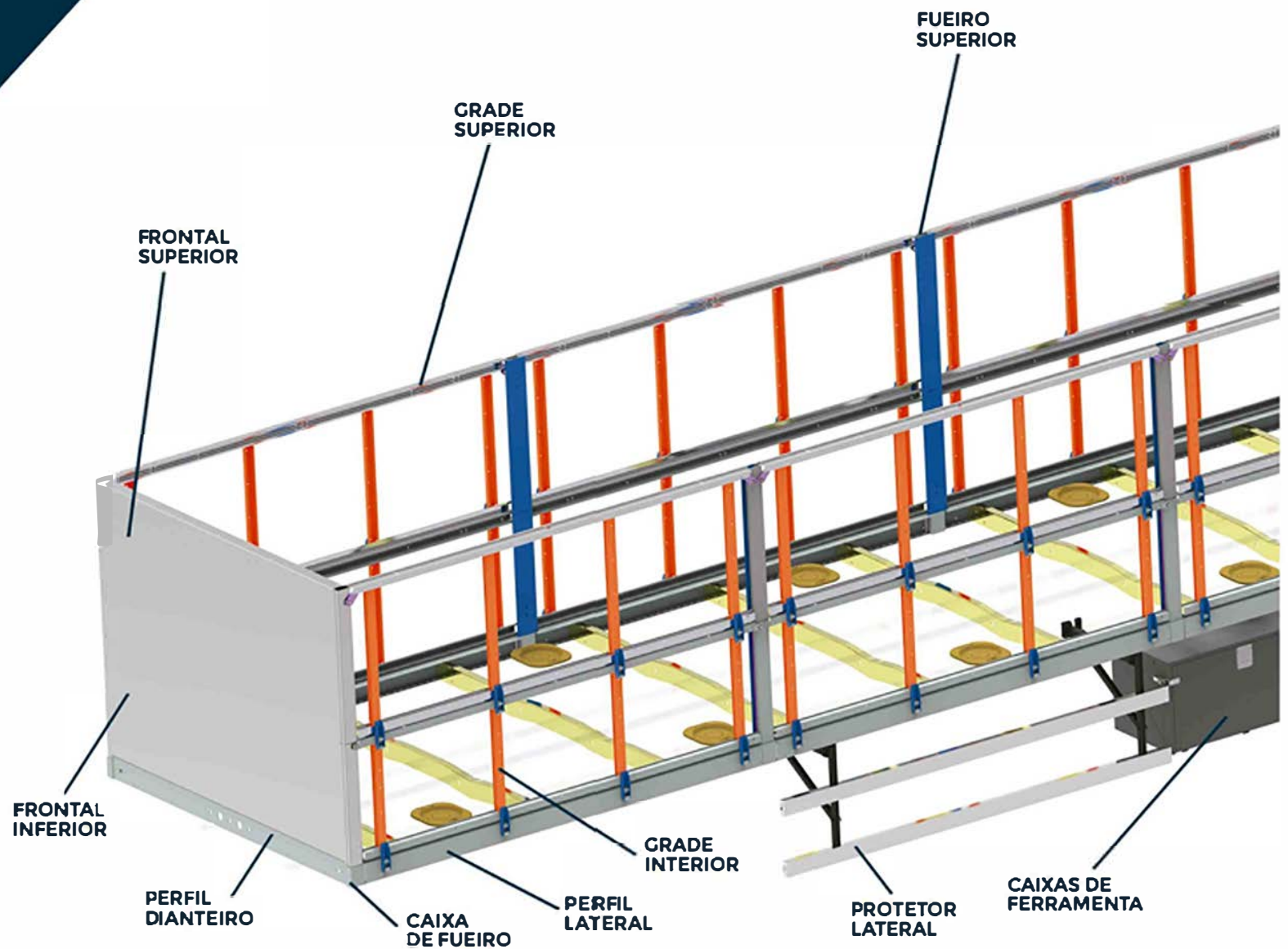

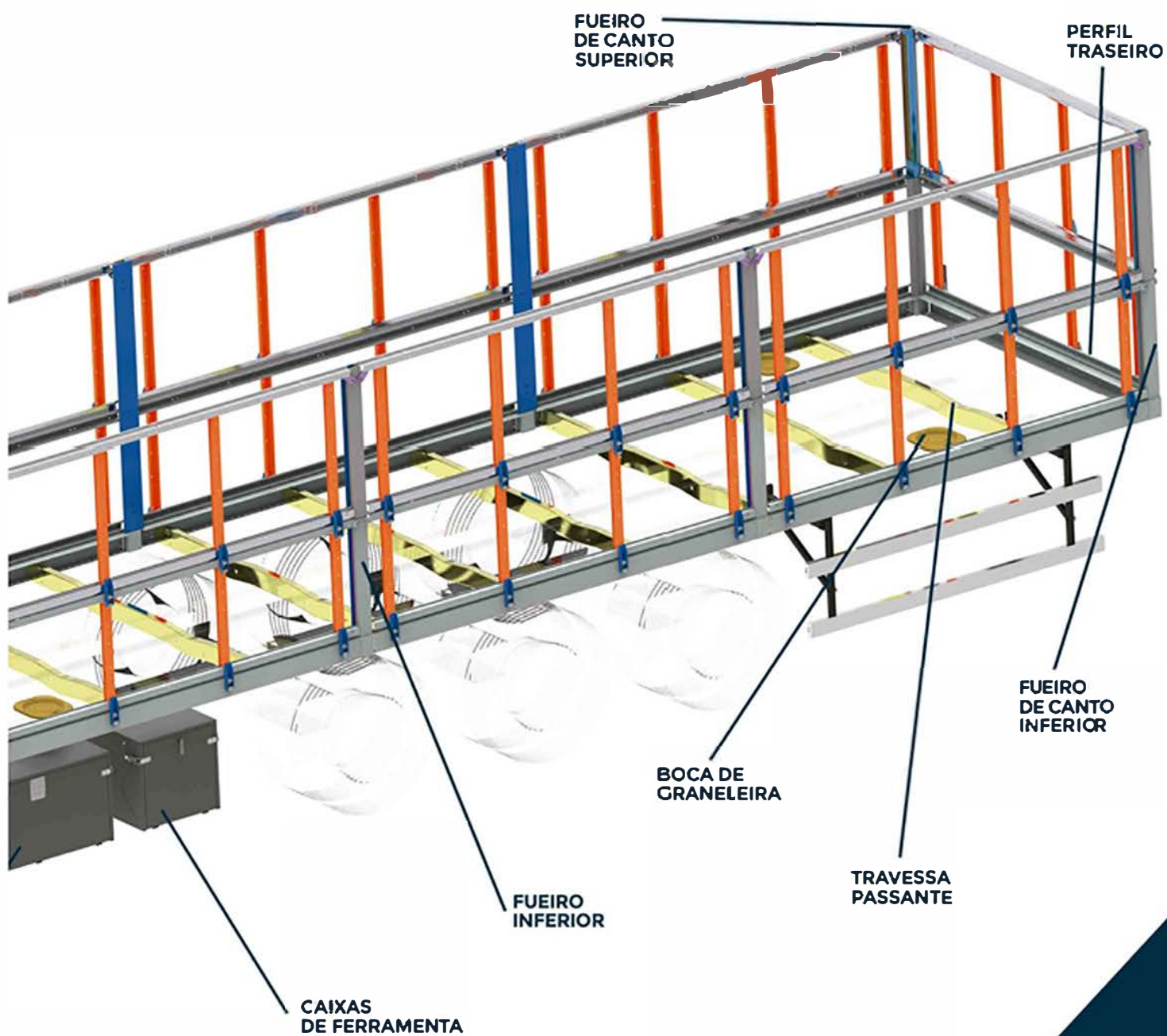

COMPATÍVEL COM LINHA

GUERRA



LINHA CARRETAS ANTIGAS PARA TAMPA DE MADEIRA



GRADE LATERAL INFERIOR

Código	alt. (mm)	larg. (mm)
FG0001A	550	2212
FG0001B	550	2430
FR0001C	550	2965
FG0001D	600	2212
FG0001E	600	2430
FG0001F	600	2965
FG0001G	650	2212

Código	alt. (mm)	larg. (mm)
FG0001H	650	2430
FG0001I	650	2965
FG0001J	700	2212
FG0001K	700	2430
FG0001L	700	2965
FG0001M	800	2212
FG0001N	800	2430

Código	alt. (mm)	larg. (mm)
FG0001O	800	2965
FG0001P	900	2212
FG0001Q	900	2430
FG0001R	900	2965
FG0001S	1000	2212
FG0001T	1000	2430
FG0001U	1000	2965



GRADE LATERAL SUPERIOR

Código	alt. (mm)	larg. (mm)
FG0002A	550	2212
FG0002B	550	2430
FG0002C	550	2965
FG0002D	600	2212
FG0002E	600	2430
FG0002F	600	2965
FG0002G	650	2212

Código	alt. (mm)	larg. (mm)
FG0002H	650	2430
FG0002I	650	2965
FG0002J	700	2212
FG0002K	700	2430
FG0002L	700	2965
FG0002M	800	2212
FG0002N	800	2430

Código	alt. (mm)	larg. (mm)
FG0002O	800	2965
FG0002P	900	2212
FG0002Q	900	2430
FG0002R	900	2965
FG0002S	1000	2212
FG0002T	1000	2430
FG0002U	1000	2965



COMPATÍVEL COM LINHA

GUERRA

LINHA CARRETAS ANTIGAS PARA TAMPA DE MADEIRA



GRADE TRASEIRA INFERIOR

Código	alt. (mm)	larg. (mm)
FG0004A	550	2430
FG0004B	600	2430
FG0004C	650	2430
FG0004D	700	2430
FG0004E	800	2430
FG0004F	900	2430
FG0004G	1000	2430



GRADE TRASEIRA SUPERIOR

Código	alt. (mm)	larg. (mm)
FG0005A	550	2430
FG0005B	600	2430
FG0005C	650	2430
FG0005D	700	2430
FG0005E	800	2430
FG0005F	900	2430
FG0005G	1000	2430

COMPATÍVEL COM LINHA

GUERRA



LINHA FUEIROS ANTIGOS

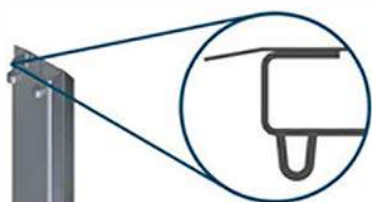

FUEIRO LATERAL INFERIOR

Código	alt. (mm)	larg. (mm)
FG0103A	550	104
FG0103B	600	104
FG0103C	650	104
FG0103D	700	104
FG0103E	800	104
FG0103F	900	104
FG0103G	1000	104

FUEIRO LATERAL SUPERIOR

Código	alt. (mm)	larg. (mm)
FG0104A	550	104
FG0104B	600	104
FG0104C	650	104
FG0104D	700	104
FG0104E	800	104
FG0104F	900	104
FG0104G	1000	104

FUEIRO DE CANTO INFERIOR DIREITO

Código	alt. (mm)	larg. (mm)
FG0105A	550	104
FG0105B	600	104
FG0105C	650	104
FG0105D	700	104
FG0105E	800	104
FG0105F	900	104
FG0105G	1000	104

FUEIRO DE CANTO INFERIOR ESQUERDO

Código	alt. (mm)	larg. (mm)
FG0106A	550	104
FG0106B	600	104
FG0106C	650	104
FG0106D	700	104
FG0106E	800	104
FG0106F	900	104
FG0106G	1000	104

FUEIRO DE CANTO SUPERIOR DIREITO

Código	alt. (mm)	larg. (mm)
FG0107A	550	104
FG0107B	600	104
FG0107C	650	104
FG0107D	700	104
FG0107E	800	104
FG0107F	900	104
FG0107G	1000	104

FUEIRO DE CANTO SUPERIOR ESQUERDO

Código	alt. (mm)	larg. (mm)
FG0108A	550	104
FG0108B	600	104
FG0108C	650	104
FG0108D	700	104
FG0108E	800	104
FG0108F	900	104
FG0108G	1000	104



COMPATÍVEL COM LINHA

GUERRA

LINHA FRONTAIS ANTIGOS

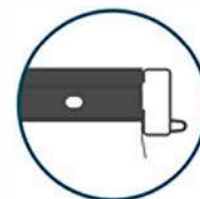

FRONTAL INFERIOR

Código	alt. (mm)	Código	alt. (mm)
FG0300A	550	FG0300E	800
FG0300B	600	FG0300F	900
FG0300C	650	FG0300C	1000
FG0300D	700		

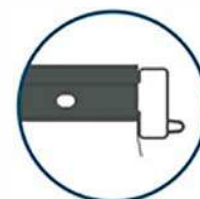
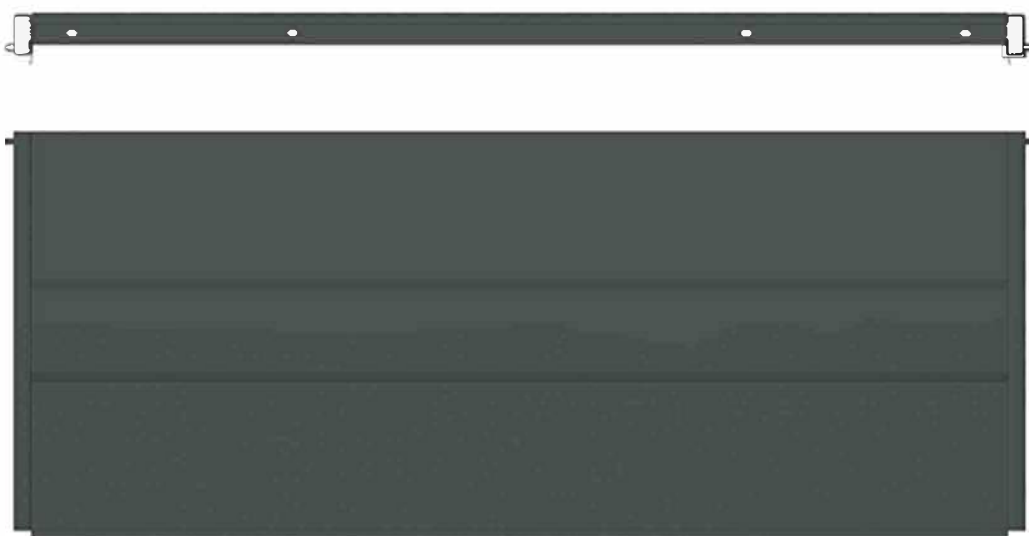

FRONTAL SUPERIOR

Código	alt. (mm)	Código	alt. (mm)
FG0301A	550	FG0301E	800
FG0301B	600	FG0301F	900
FG0301C	650	FG0301C	1000
FG0301D	700		

COMPATÍVEL COM LINHA

GUERRA



LINHA CARRETAS TECNO 5 PARA TAMPA DE MADEIRA



GRADE LATERAL INFERIOR

Código	alt. (mm)	larg. (mm)
FG0001A	550	2212
FG0001B	550	2430
FR0001C	550	2965
FG0001D	600	2212
FG0001E	600	2430
FG0001F	600	2965
FG0001G	650	2212

Código	alt. (mm)	larg. (mm)
FG0001H	650	2430
FG0001I	650	2965
FG0001J	700	2212
FG0001K	700	2430
FG0001L	700	2965
FG0001M	800	2212
FG0001N	800	2430

Código	alt. (mm)	larg. (mm)
FG0001O	800	2965
FG0001P	900	2212
FG0001Q	900	2430
FG0001R	900	2965
FG0001S	1000	2212
FG0001T	1000	2430
FG0001U	1000	2965



GRADE LATERAL SUPERIOR

Código	alt. (mm)	larg. (mm)
FG0003A	550	2212
FG0003B	550	2430
FG0003C	550	2965
FG0003D	600	2212
FG0003E	600	2430
FG0003F	600	2965
FG0003G	650	2212

Código	alt. (mm)	larg. (mm)
FG0003H	650	2430
FG0003I	650	2965
FG0003J	700	2212
FG0003K	700	2430
FG0003L	700	2965
FG0003M	800	2212
FG0003N	800	2430

Código	alt. (mm)	larg. (mm)
FG0003O	800	2965
FG0003P	900	2212
FG0003Q	900	2430
FG0003R	900	2965
FG0003S	1000	2212
FG0003T	1000	2430
FG0003U	1000	2965



COMPATÍVEL COM LINHA

GUERRA

LINHA CARRETAS TECNO 5 PARA TAMPA DE MADEIRA

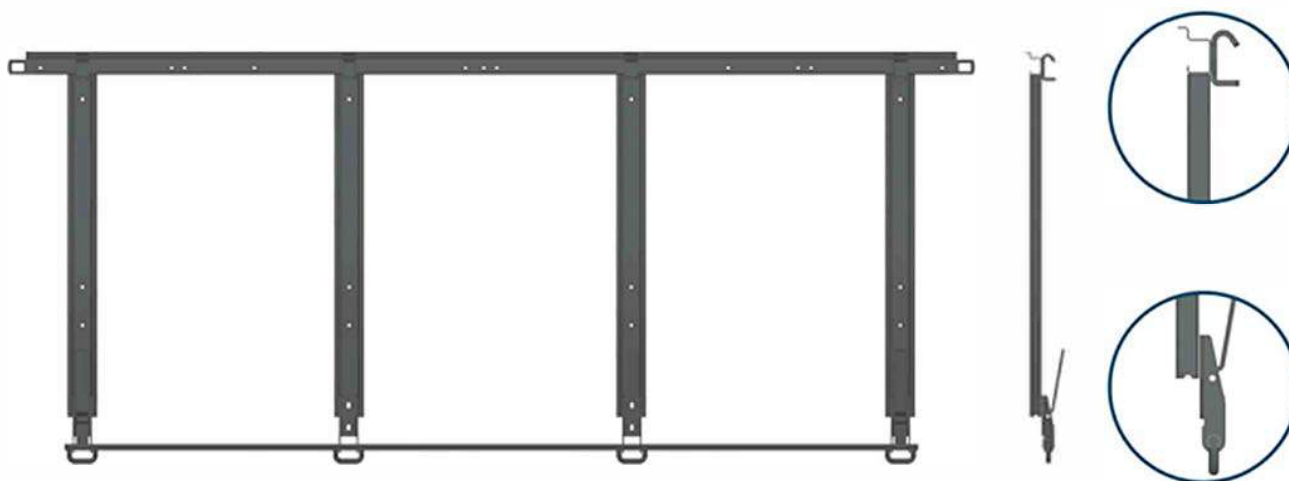

GRADE TRASEIRA INFERIOR

Código	alt. (mm)	larg. (mm)
FG0004A	550	2430
FG0004B	600	2430
FG0004C	650	2430
FG0004D	700	2430
FG0004E	800	2430
FG0004F	900	2430
FG0004C	1000	2430

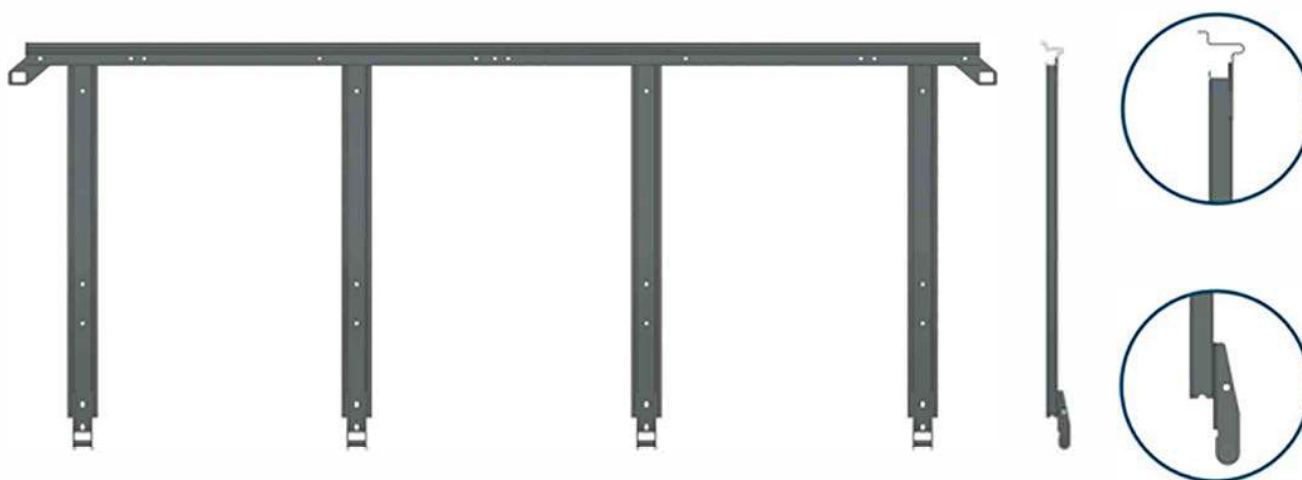

GRADE TRASEIRA SUPERIOR

Código	alt. (mm)	larg. (mm)
FG0006A	550	2430
FG0006B	600	2430
FG0006C	650	2430
FG0006D	700	2430
FG0006E	800	2430
FG0006F	900	2430
FG0006C	1000	2430

COMPATÍVEL COM LINHA

GUERRA



LINHA FUEIROS TECNO 5

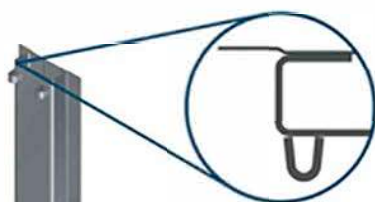

FUEIRO LATERAL INFERIOR

Código	alt. (mm)	larg. (mm)
FG0109A	550	104
FG0109B	600	104
FG0109C	650	104
FG0109D	700	104
FG0109E	800	104
FG0109F	900	104
FG0109G	1000	104



FUEIRO LATERAL SUPERIOR

Código	alt. (mm)	larg. (mm)
FG0110A	550	104
FG0110B	600	104
FG0110C	650	104
FG0110D	700	104
FG0110E	800	104
FG0110F	900	104
FG0110G	1000	104



FUEIRO DE CANTO INFERIOR DIREITO

Código	alt. (mm)	larg. (mm)
FG0111A	550	104
FG0111B	600	104
FG0111C	650	104
FG0111D	700	104
FG0111E	800	104
FG0111F	900	104
FG0111G	1000	104



FUEIRO DE CANTO INFERIOR ESQUERDO

Código	alt. (mm)	larg. (mm)
FG0112A	550	104
FG0112B	600	104
FG0112C	650	104
FG0112D	700	104
FG0112E	800	104
FG0112F	900	104
FG0112G	1000	104



FUEIRO DE CANTO SUPERIOR DIREITO

Código	alt. (mm)	larg. (mm)
FG0113A	550	104
FG0113B	600	104
FG0113C	650	104
FG0113D	700	104
FG0113E	800	104
FG0113F	900	104
FG0113G	1000	104



FUEIRO DE CANTO SUPERIOR ESQUERDO

Código	alt. (mm)	larg. (mm)
FG0114A	550	104
FG0114B	600	104
FG0114C	650	104
FG0114D	700	104
FG0114E	800	104
FG0114F	900	104
FG0114G	1000	104



COMPATÍVEL COM LINHA

GUERRA

LINHA FRONTAIS TECNO 5

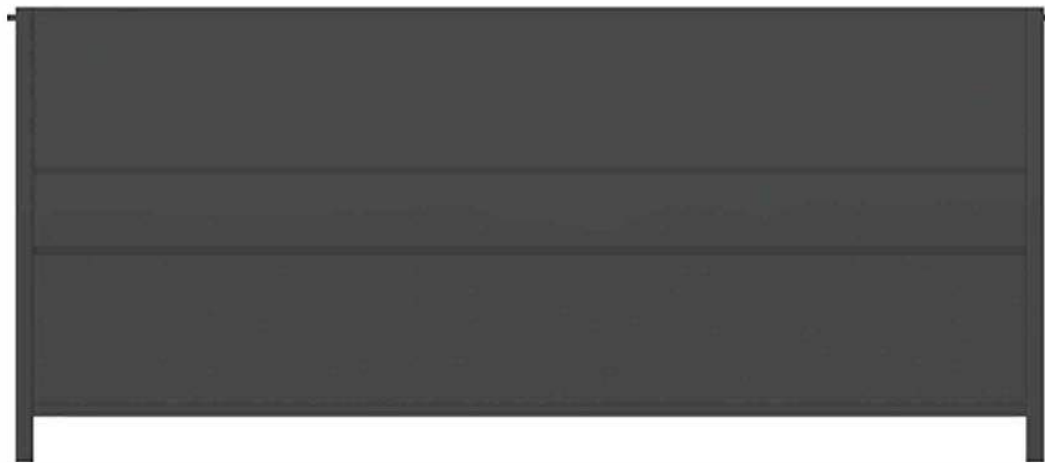

FRONTAL INFERIOR

Código	alt. (mm)	Código	alt. (mm)
FG0304A	550	FG0304E	800
FG0304B	600	FG0304F	900
FG0304C	650	FG0304G	1000
FG0304D	700		

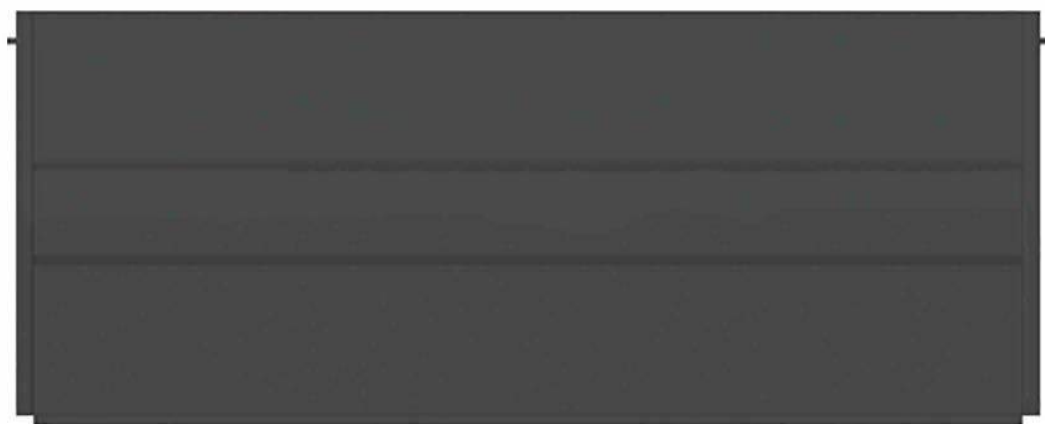

FRONTAL SUPERIOR

Código	alt. (mm)	Código	alt. (mm)
FG0305A	550	FG0305E	800
FG0305B	600	FG0305F	900
FG0305C	650	FG0305G	1000
FG0305D	700		

COMPATÍVEL COM LINHA

GUERRA



LINHA CARRETAS TECNO 10 PARA TAMPA DE MADEIRA



GRADE LATERAL INFERIOR

Código	alt. (mm)	larg. (mm)
FG0007A	550	2212
FG0007B	550	2430
FR0007C	550	2965
FG0007D	600	2212
FG0007E	600	2430
FG0007F	600	2965
FG0007G	650	2212

Código	alt. (mm)	larg. (mm)
FG0007H	650	2430
FG0007I	650	2965
FG0007J	700	2212
FG0007K	700	2430
FG0007L	700	2965
FG0007M	800	2212
FG0007N	800	2430

Código	alt. (mm)	larg. (mm)
FG0007O	800	2965
FG0007P	900	2212
FG0007Q	900	2430
FG0007R	900	2965
FG0007S	1000	2212
FG0007T	1000	2430
FG0007U	1000	2965



GRADE LATERAL SUPERIOR

Código	alt. (mm)	larg. (mm)
FG0008A	550	2212
FG0008B	550	2430
FG0008C	550	2965
FG0008D	600	2212
FG0008E	600	2430
FG0008F	600	2965
FG0008G	650	2212

Código	alt. (mm)	larg. (mm)
FG0008H	650	2430
FG0008I	650	2965
FG0008J	700	2212
FG0008K	700	2430
FG0008L	700	2965
FG0008M	800	2212
FG0008N	800	2430

Código	alt. (mm)	larg. (mm)
FG0008O	800	2965
FG0008P	900	2212
FG0008Q	900	2430
FG0008R	900	2965
FG0008S	1000	2212
FG0008T	1000	2430
FG0008U	1000	2965



COMPATÍVEL COM LINHA

GUERRA

LINHA CARRETAS TECNO 10 PARA TAMPA DE MADEIRA

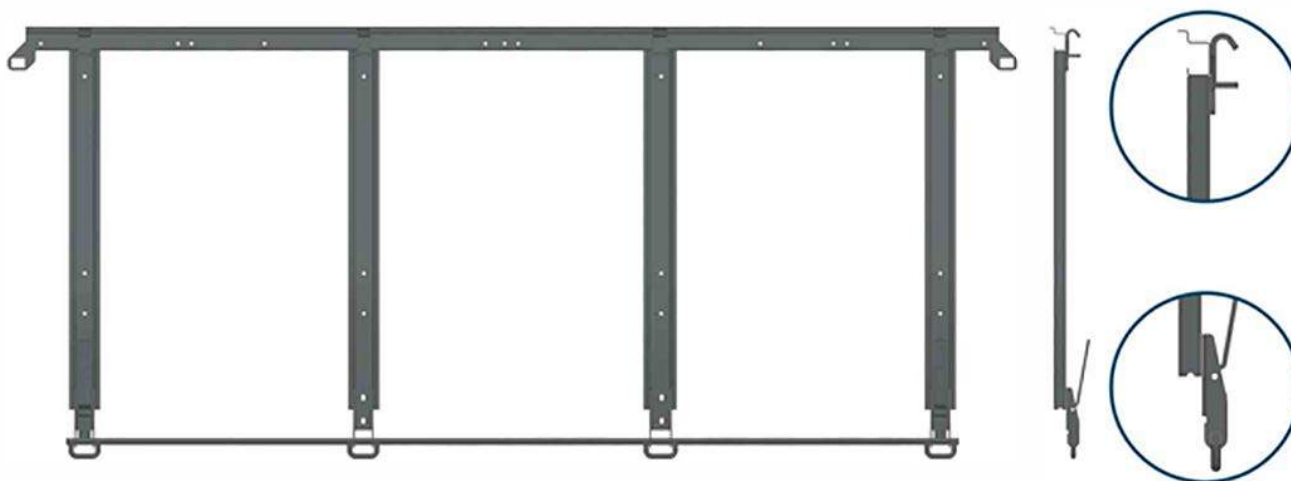

GRADE TRASEIRA INFERIOR

Código	alt. (mm)	larg. (mm)
FG0009A	550	2430
FG0009B	600	2430
FG0009C	650	2430
FG0009D	700	2430
FG0009E	800	2430
FG0009F	900	2430
FG0009G	1000	2430



GRADE TRASEIRA SUPERIOR

Código	alt. (mm)	larg. (mm)
FG0011A	550	2430
FG0011B	600	2430
FG0011C	650	2430
FG0011D	700	2430
FG0011E	800	2430
FG0011F	900	2430
FG0011G	1000	2430

COMPATÍVEL COM LINHA

GUERRA



LINHA FUEIROS TECNO 10

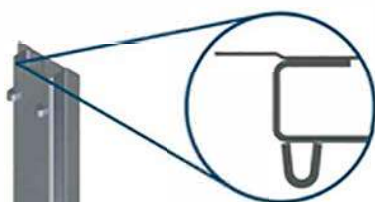

FUEIRO LATERAL INFERIOR

Código	alt. (mm)	larg. (mm)
FC0115A	550	104
FC0115B	600	104
FC0115C	650	104
FC0115D	700	104
FC0115E	800	104
FC0115F	900	104
FC0115C	1000	104

FUEIRO LATERAL SUPERIOR

Código	alt. (mm)	larg. (mm)
FC0110A	550	104
FC0110B	600	104
FC0110C	650	104
FC0110D	700	104
FC0110E	800	104
FC0110F	900	104
FC0110C	1000	104

FUEIRO DE CANTO INFERIOR DIREITO

Código	alt. (mm)	larg. (mm)
FC0117A	550	104
FC0117B	600	104
FC0117C	650	104
FC0117D	700	104
FC0117E	800	104
FC0117F	900	104
FC0117C	1000	104

FUEIRO DE CANTO INFERIOR ESQUERDO

Código	alt. (mm)	larg. (mm)
FC0118A	550	104
FC0118B	600	104
FC0118C	650	104
FC0118D	700	104
FC0118E	800	104
FC0118F	900	104
FC0118C	1000	104

FUEIRO DE CANTO SUPERIOR DIREITO

Código	alt. (mm)	larg. (mm)
FC0113A	550	104
FC0113B	600	104
FC0113C	650	104
FC0113D	700	104
FC0113E	800	104
FC0113F	900	104
FC0113C	1000	104

FUEIRO DE CANTO SUPERIOR ESQUERDO

Código	alt. (mm)	larg. (mm)
FC0114A	550	104
FC0114B	600	104
FC0114C	650	104
FC0114D	700	104
FC0114E	800	104
FC0114F	900	104
FC0114C	1000	104



COMPATÍVEL COM LINHA

GUERRA

LINHA FRONTAIS TECNO 10

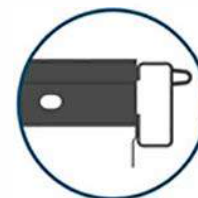

FRONTAL INFERIOR

Código	alt. (mm)	Código	alt. (mm)
FG0306A	550	FG0306E	800
FG0306B	600	FG0306F	900
FG0306C	650	FG0306G	1000
FG0306D	700		

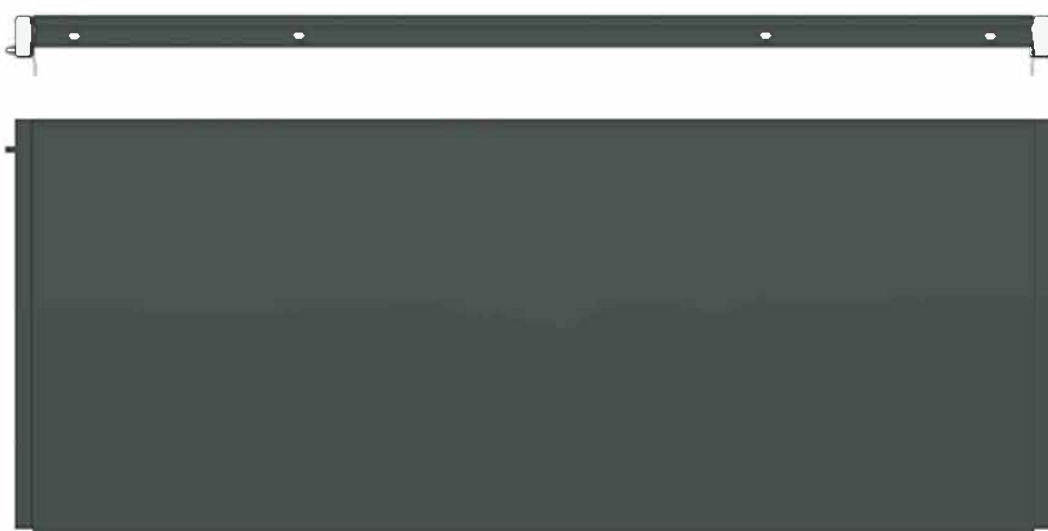

FRONTAL SUPERIOR

Código	alt. (mm)	Código	alt. (mm)
FG0307A	550	FG0307E	800
FG0307B	600	FG0307F	900
FG0307C	650	FG0307G	1000
FG0307D	700		

COMPATÍVEL COM LINHA

GUERRA



DIVERSOS



COLUNA INFERIOR

Código	comp. (mm)	Código	comp. (mm)
FG0035AA	450	FG0035EA	700
FG0035BA	500	FG0035FA	800
FG0035CA	550	FG0035GA	900
FG0035DA	600		



COLUNA SUPERIOR

Código	comp. (mm)	Código	comp. (mm)
FG0033AA	450	FG0033EA	700
FG0033BA	500	FG0033FA	800
FG0033CA	550	FG0033GA	900
FG0033DA	600		



COLUNA INFERIOR/SUPERIOR

Código	comp. (mm)	Código	comp. (mm)
FG0027AA	450	FG0027EA	700
FG0027BA	500	FG0027FA	800
FG0027CA	550	FG0027GA	900
FG0027DA	600		

DIVERSOS

VIGUETA SUPERIOR P/ TAMPA INFERIOR

Código	comp. (mm)
FG0040A	2212
FG0040B	2430
FG0040C	2965

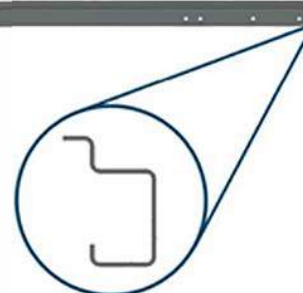

VIGUETA SUPERIOR P/ TAMPA SUPERIOR C/ FURAÇÃO DO ARCO

Código	comp. (mm)
FG0043A	2212
FG0043B	2430
FG0043C	2965



COLUNA GRADE TRASEIRA SUP. COM DOBRADIÇA

Código	comp. (mm)	Código	comp. (mm)
FG0029AA	450	FG0029EA	700
FG0029BA	500	FG0029FA	800
FG0029CA	550	FG0029GA	900
FG0029DA	600		



COLUNA GRADE LATERAL COM DOBRADIÇA

Código	comp. (mm)	Código	comp. (mm)
FG0028AA	450	FG0028EA	700
FG0028BA	500	FG0028FA	800
FG0028CA	550	FG0028GA	900
FG0028DA	600		



FG0010 CONJUNTO TAMPA TRASEIRA INFERIOR

COMPATÍVEL COM LINHA

GUERRA



DIVERSOS

FG0205A
PERFIL DIANTEIRO
2430mm

FG205B
PERFIL DIANTEIRO
TECNO 5 2430mm

FG0205C
PERFIL DIANTEIRO
TECNO 5 COM
SAIDA ABS 2430mm

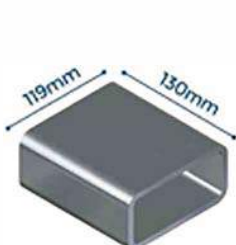

FG0121
CAIXA DO FUEIRO

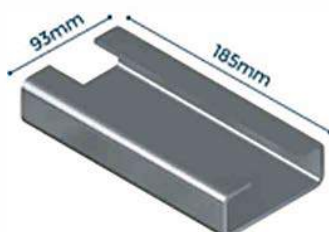

FG0122
ENCAIXE DO FUEIRO

FG0204I
PERFIL LATERAL 2212mm
FG0204G
PERFIL LATERAL 2430mm
FG0204F
PERFIL LATERAL 2965mm

FG0204E
PERFIL LATERAL
COM FURAÇÃO 2212mm
FG0204C
PERFIL LATERAL
COM FURAÇÃO 2430mm
FG0204B
PERFIL LATERAL
COM FURAÇÃO 2965mm

FG0204A
PERFIL TRASEIRO 2430mm
(esp. 4,25mm)
FG0204D
PERFIL TRASEIRO 2430mm
REFORÇADO (esp. 6,35mm)

FG0204K
PERFIL TRASEIRO
COM FURAÇÃO 2430mm
(esp. 4,25mm)

FG0204H
PERFIL TRASEIRO
COM FURAÇÃO 2430mm
REFORÇADO (esp. 6,35mm)



DIVERSOS



FG0026
DOBRADIÇA MODERNA

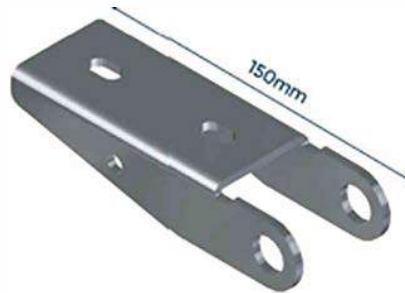

FG0014
DOBRADIÇA DO
TOMBADOR INFERIOR



FG0017
DOBRADIÇA DO
TOMBADOR SUPERIOR



FG0026B
DOBRADIÇA ANTIGA

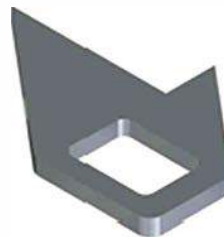

FG0020A
ENGATE FÊMEA
SUPERIOR TECNO 5

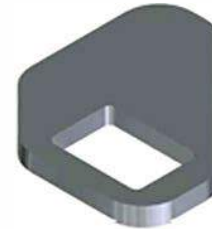

FG0020C
ENGATE FÊMEA
INFERIOR/SUPERIOR
TECNO 10

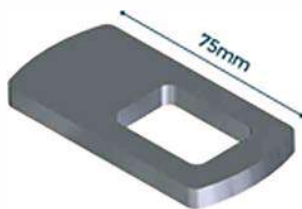

FG0020D
ENGATE FÊMEA
INFERIOR



FG0020B
ENGATE FÊMEA
TECNO 10



F4039
ARANHA DO
ASSOALHO



FG0015
GANCHO
TOMBADOR

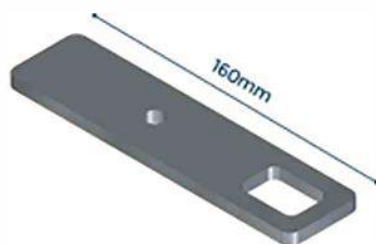

FG0018
ENGATE FÊMEA DA
GRADE TRASEIRA

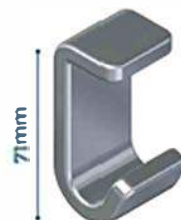

FR0011A
ENGATE RÁPIDO
TIPO "G"



FR0016
DESLIZANTE
DO TOMBADOR

COMPATÍVEL COM LINHA

GUERRA



DIVERSOS



F4203
BOCA DE GRANELEIRA
GUERRA (NYLON)



F4204A
TAMPA BOCA DE
GRANELEIRA GUERRA

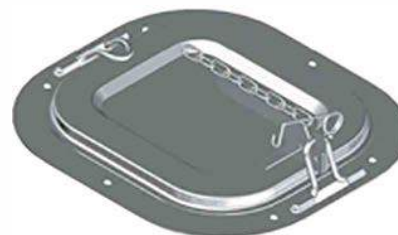

F4204
BOCA DE
GRANELEIRA
GUERRA



FG0240
RÉGUA PARABARRO
695mm



FG0115T
TAMPA DO FUEIRO
GUERRA (PLÁSTICA)



FG0038T
TAMPA DA VIGUETA
GUERRA (PLÁSTICA)



FG0240A
SUPORTE CENTRAL
SAIA 810mm

FG0240B
SUPORTE CENTRAL
SAIA 830mm

FG0240C
SUPORTE CENTRAL
SAIA 860mm

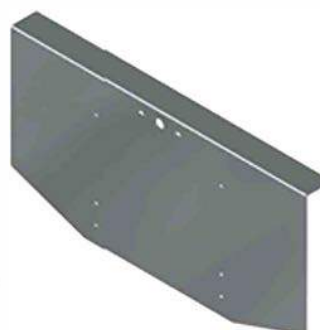

FG0251
SUPORTE DE PLACA

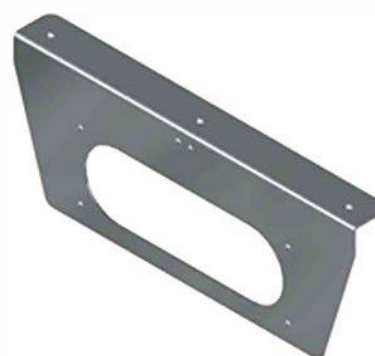

FG0252
SUPORTE SINALEIRA
GUERRA





COMPATÍVEL COM LINHA

GUERRA

LANÇAMENTOS
DIVERSOS



FG0260
SUPORTE PÉ DE APOIO
GUERRA 400mm



FG0261
SUPORTE PÉ DE APOIO
GUERRA 460mm



FG0253
SUPORTE SINALEIRA TRASEIRA
DO DOLLY GUERRA 2440mm

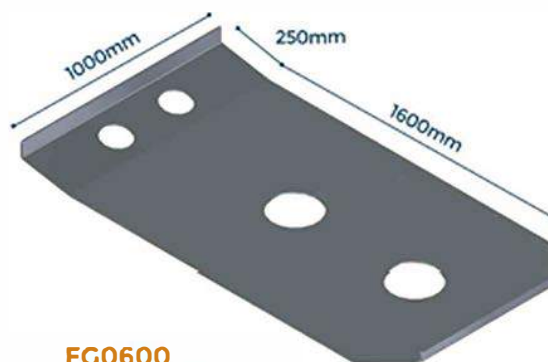

FG0600
MESA PINO REI DA
CARRETA GUERRA
CHAPA 7,94mm

FG0600A
MESA PINO REI DA
CARRETA GUERRA
CHAPA 9,54mm



FG0601
MESA PINO REI
1º BITREM GUERRA
CHAPA 7,94mm

FG0601A
MESA PINO REI
1º BITREM GUERRA
CHAPA 9,54mm

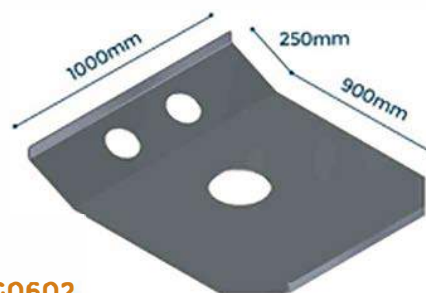

FG0602
MESA PINO REI
2º BITREM GUERRA
CHAPA 7,94mm

FG0602A
MESA PINO REI
2º BITREM GUERRA
CHAPA 9,54mm

PEÇAS COMPATÍVEIS COM

linha LIBRELATO

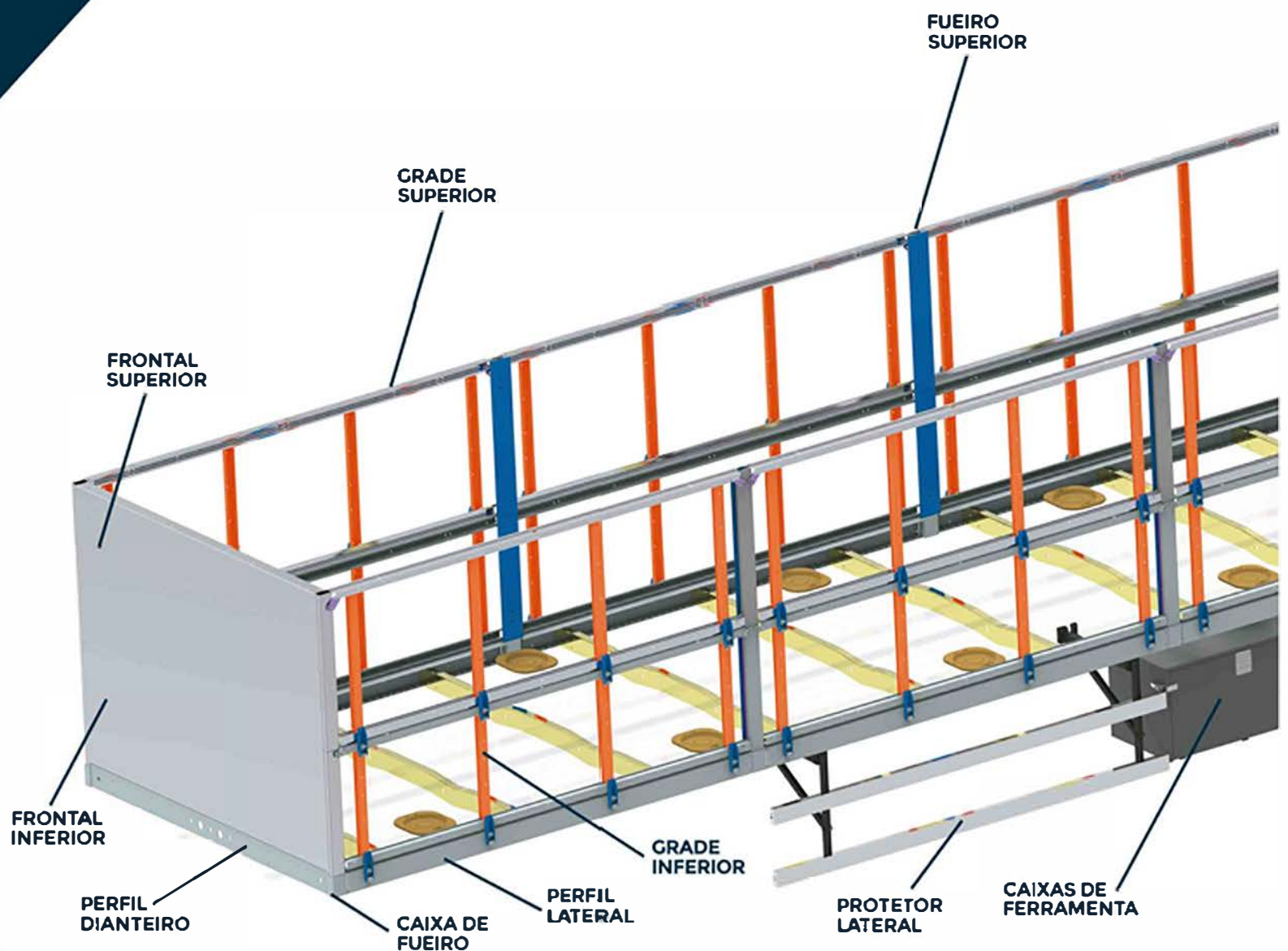

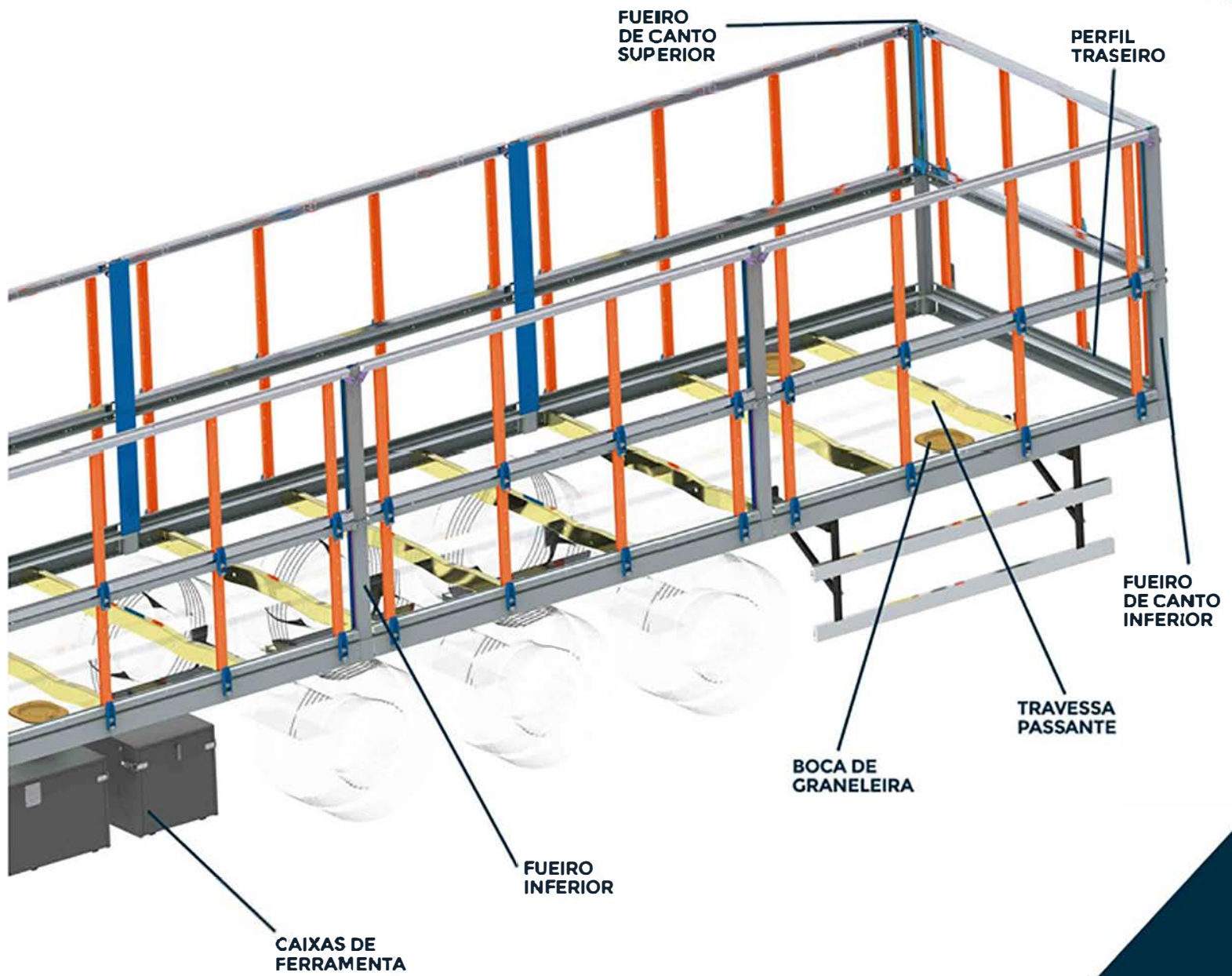
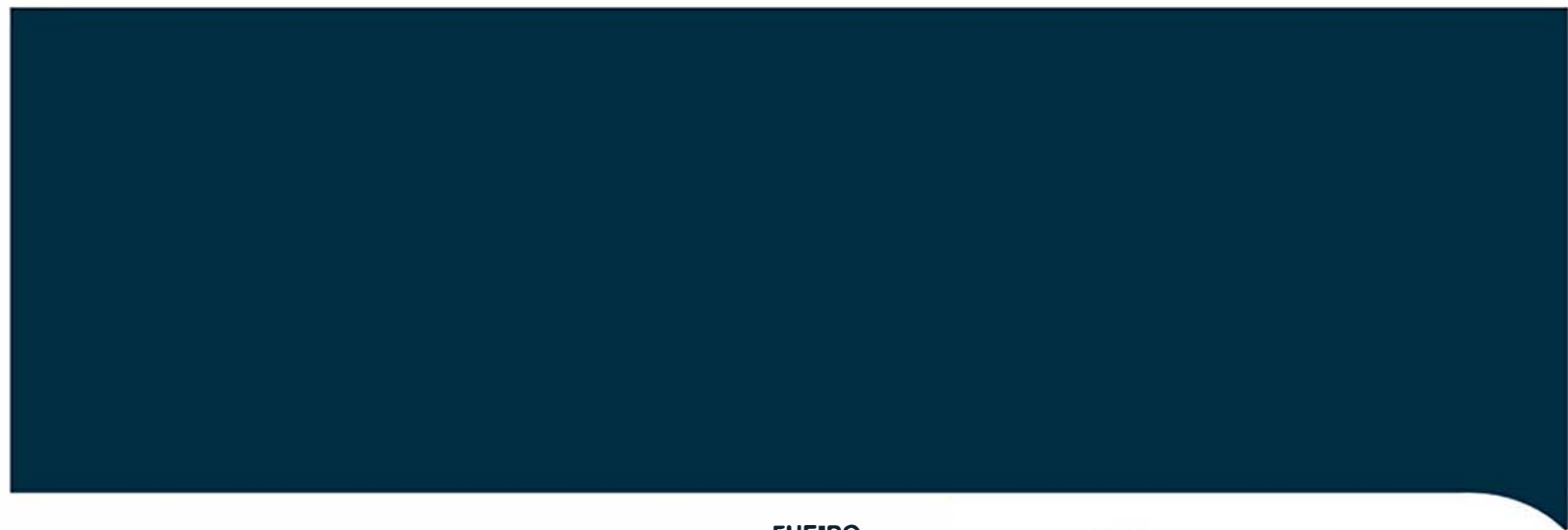

COMPATÍVEL COM LINHA

LIBRELATO



LINHA CARRETAS ANTIGAS



GRADE LATERAL INFERIOR

Código	alt. (mm)	larg. (mm)	Código	alt. (mm)	larg. (mm)
FL0001A	650	2230	FL0001V	900	2230
FL0001K	650	2590	FL0001X	900	2590
FL0001L	650	2970	FL0001Z	900	2970
FL0001Q	800	2230	FL0001AA	1000	2230
FL0001S	800	2590	FL0001AC	1000	2590
FL0001T	800	2970	FL0001AD	1000	2970



GRADE LATERAL SUPERIOR

Código	alt. (mm)	larg. (mm)	Código	alt. (mm)	larg. (mm)
FL0002A	650	2230	FL0002V	900	2230
FL0002K	650	2590	FL0002X	900	2590
FL0002L	650	2970	FL0002Z	900	2970
FL0002Q	800	2230	FL0002AA	1000	2230
FL0002S	800	2590	FL0002AC	1000	2590
FL0002T	800	2970	FL0002AD	1000	2970

LINHA CARRETAS ANTIGAS

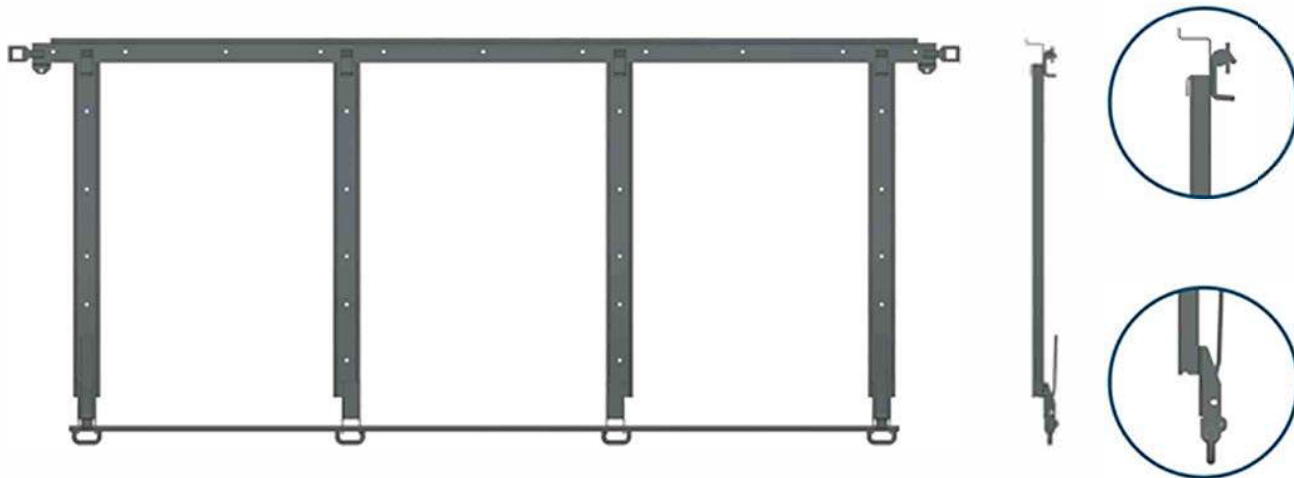

GRADE TRASEIRA INFERIOR

Código	alt. (mm)	larg. (mm)
FL0004A	650	2420
FL0004E	800	2420
FL0004F	900	2420
FL0004G	1000	2420



GRADE TRASEIRA SUPERIOR

Código	alt. (mm)	larg. (mm)
FL0005A	650	2420
FL0005E	800	2420
FL0005F	900	2420
FL0005G	1000	2420

COMPATÍVEL COM LINHA

LIBRELATO



LINHA FUEIROS ANTIGOS

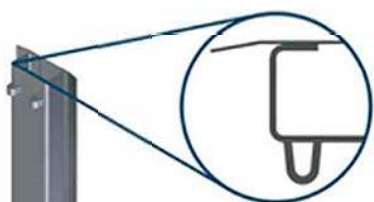

FUEIRO LATERAL INFERIOR

Código	alt. (mm)	larg. (mm)
FL0103C	650	96
FL0103E	800	96
FL0103F	900	96
FL0103G	1000	96

FUEIRO LATERAL SUPERIOR

Código	alt. (mm)	larg. (mm)
FL0104C	650	96
FL0104E	800	96
FL0104F	900	96
FL0104G	1000	96

FUEIRO DE CANTO INFERIOR DIREITO

Código	alt. (mm)	larg. (mm)
FL0105C	650	96
FL0105E	800	96
FL0105F	900	96
FL0105G	1000	96

FUEIRO DE CANTO INFERIOR ESQUERDO

Código	alt. (mm)	larg. (mm)
FL0106C	650	96
FL0106E	800	96
FL0106F	900	96
FL0106G	1000	96

FUEIRO DE CANTO SUPERIOR DIREITO

Código	alt. (mm)	larg. (mm)
FL0107C	650	96
FL0107E	800	96
FL0107F	900	96
FL0107G	1000	96

FUEIRO DE CANTO SUPERIOR ESQUERDO

Código	alt. (mm)	larg. (mm)
FL0108C	650	96
FL0108E	800	96
FL0108F	900	96
FL0108G	1000	96



COMPATÍVEL COM LINHA

LIBRELATO

LINHA FRONTAIS ANTIGOS

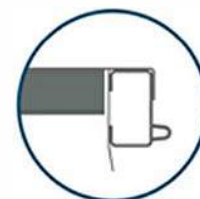
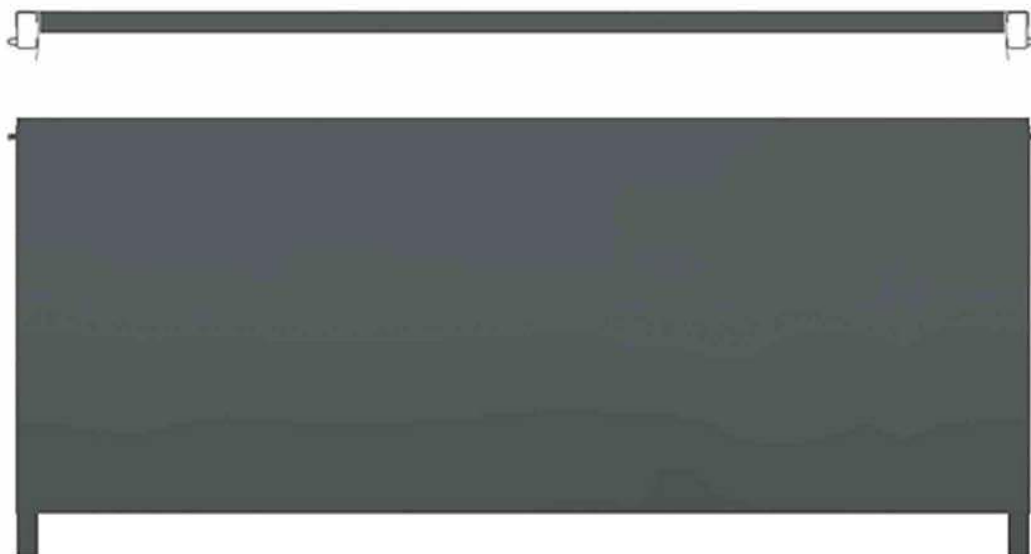

FRONTAL INFERIOR

Código	alt. (mm)
FLO300C	650
FLO300E	800
FLO300F	900
FLO300G	1000

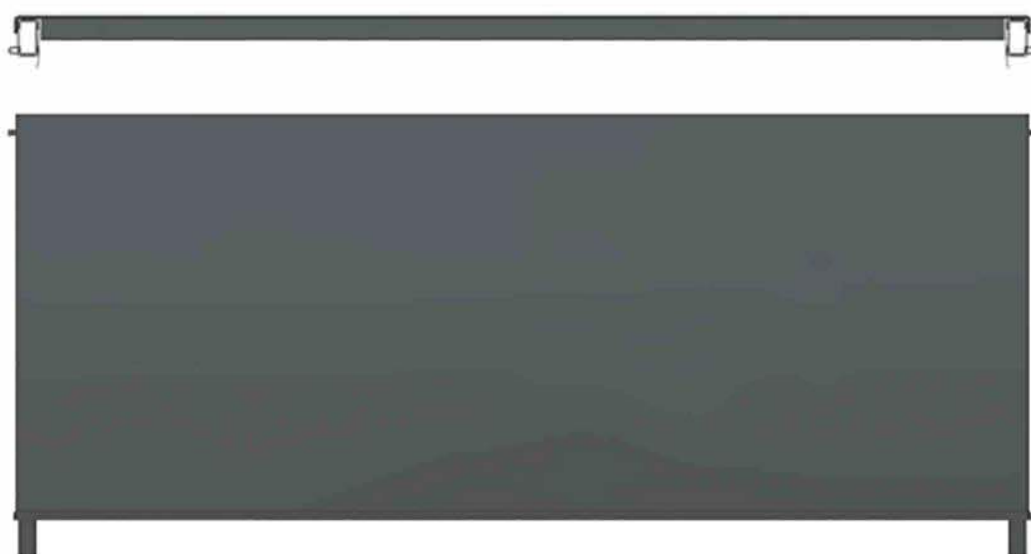

FRONTAL SUPERIOR

Código	alt. (mm)
FLO303C	650
FLO303E	800
FLO303F	900
FLO303G	1000

COMPATÍVEL COM LINHA

LIBRELATO



LINHA VIGUETAS ANTIGAS



VIGUETA SUPERIOR P/ TAMPA INFERIOR

Código	comp. (mm)
FLO040	2230
FLO040B	2590
FLO040C	2970



VIGUETA SUPERIOR P/ TAMPA INFERIOR TRASEIRA

Código	comp. (mm)
FLO040D	2420



VIGUETA SUPERIOR P/ TAMPA SUPERIOR TRASEIRA

Código	comp. (mm)
FLO043A	2420

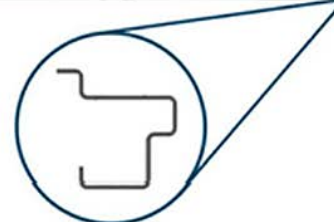

VIGUETA SUPERIOR P/ TAMPA SUPERIOR C/ FURAÇÃO DO ARCO

Código	comp. (mm)
FLO043	2230
FLO043B	2590
FLO043C	2970

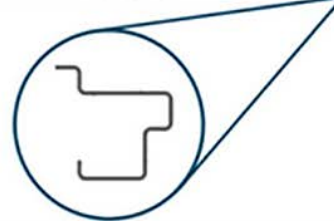

LINHA COLUNAS ANTIGAS



COLUNA GRADE INFERIOR E SUPERIOR

Código	comp. (mm)	Código	comp. (mm)
FLO027DA	550	FLO027FA	800
FLO027EA	700	FLO027GA	900



COLUNA GRADE INFERIOR E SUPERIOR COM DOBRADIÇA

Código	comp. (mm)	Código	comp. (mm)
FLO028DA	550	FLO028FA	800
FLO028EA	700	FLO028GA	900

LINHA CARRETAS HORIZON

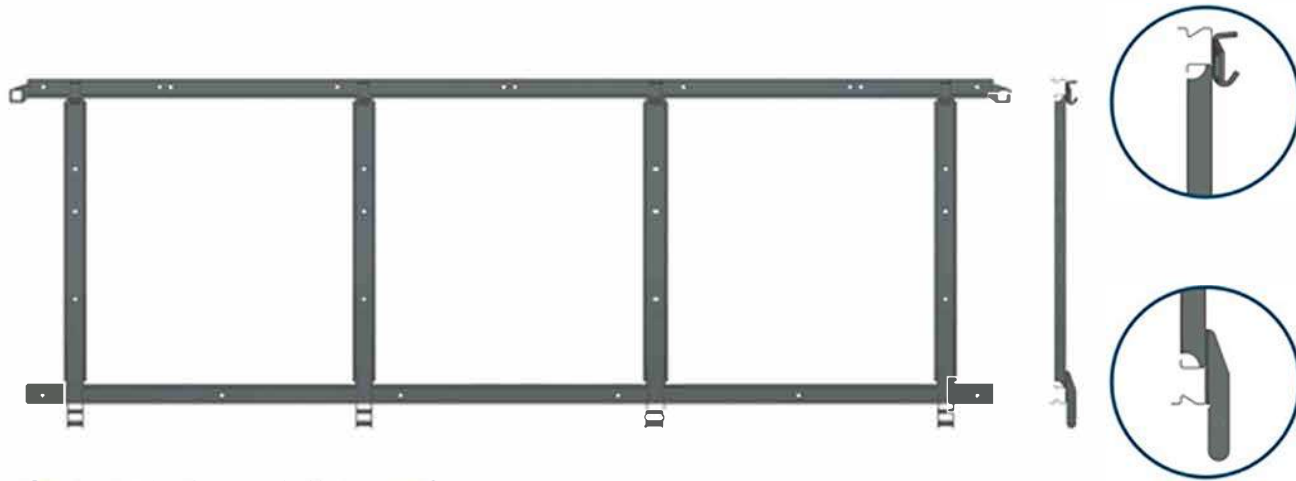

GRADE LATERAL INFERIOR

Código	alt. (mm)	larg. (mm)	Código	alt. (mm)	larg. (mm)
FL0012M	800	2230	FL0012R	900	2970
FL0012N	800	2430	FL0012S	1000	2230
FL0012O	800	2970	FL0012T	1000	2430
FL0012P	900	2230	FL0012U	1000	2970
FL0012Q	900	2430			

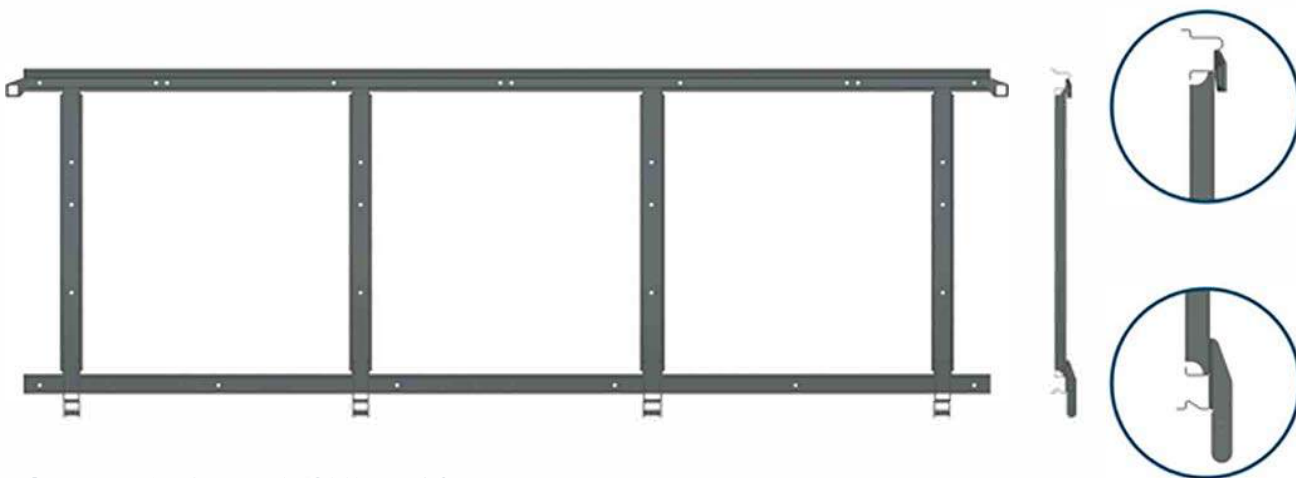

GRADE LATERAL SUPERIOR

Código	alt. (mm)	larg. (mm)	Código	alt. (mm)	larg. (mm)
FL0003M	800	2230	FL0003R	900	2970
FL0003N	800	2430	FL0003S	1000	2230
FL0003O	800	2970	FL0003T	1000	2430
FL0003P	900	2230	FL0003U	1000	2970
FL0003Q	900	2430			

COMPATÍVEL COM LINHA

LIBRELATO



LINHA CARRETAS HORIZON

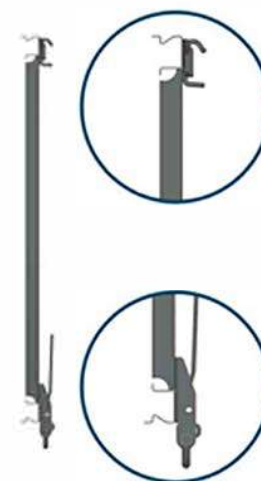
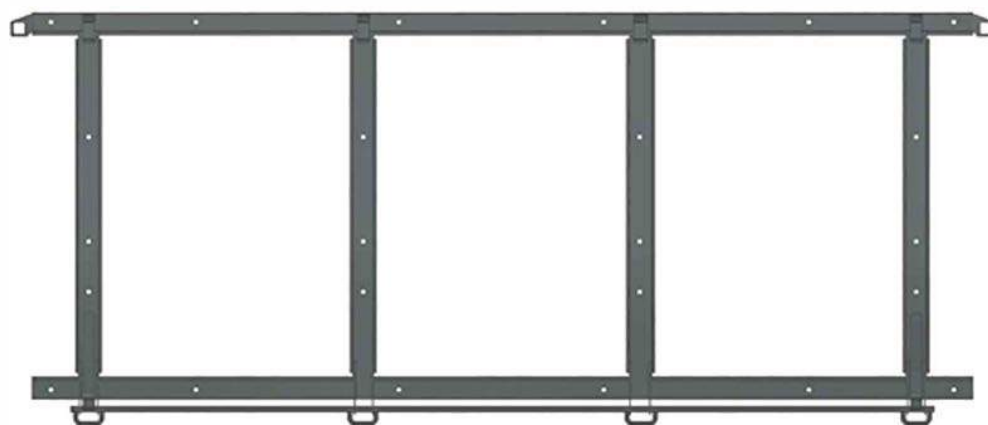

GRADE TRASEIRA INFERIOR

Código	alt. (mm)	larg. (mm)
FL0013E	800	2430
FL0013F	900	2430
FL0013G	1000	2430

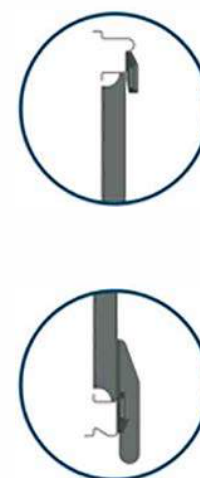

GRADE TRASEIRA SUPERIOR

Código	alt. (mm)	larg. (mm)
FL0016E	800	2430
FL0016F	900	2430
FL0016G	1000	2430

LINHA FUEIROS HORIZON

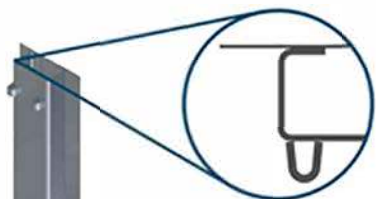

FUEIRO LATERAL INFERIOR

Código	alt. (mm)	larg. (mm)
FL0109E	800	96
FL0109F	900	96
FL0109G	1000	96



FUEIRO LATERAL SUPERIOR

Código	alt. (mm)	larg. (mm)
FL0116E	800	96
FL0116F	900	96
FL0116C	1000	96



FUEIRO DE CANTO INFERIOR DIREITO

Código	alt. (mm)	larg. (mm)
FL0111E	800	96
FL0111F	900	96
FL0111G	1000	96

FUEIRO DE CANTO INFERIOR ESQUERDO

Código	alt. (mm)	larg. (mm)
FL0112E	800	96
FL0112F	900	96
FL0112C	1000	96



FUEIRO DE CANTO SUPERIOR DIREITO

Código	alt. (mm)	larg. (mm)
FL0119E	800	96
FL0119F	900	96
FL0119C	1000	96

FUEIRO DE CANTO SUPERIOR ESQUERDO

Código	alt. (mm)	larg. (mm)
FL0120E	800	96
FL0120F	900	96
FL0120C	1000	96

COMPATÍVEL COM LINHA

LIBRELATO



LINHA FRONTAIS HORIZON

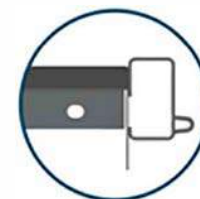

FRONTAL INFERIOR

Código	alt. (mm)
FLO304E	800
FLO304F	900
FLO304C	1000



FRONTAL SUPERIOR

Código	alt. (mm)
FLO305E	800
FLO305F	900
FLO305C	1000

LINHA VIGUETAS HORIZON



VIGUETA INFERIOR P/ TAMPA INFERIOR/SUPERIOR

Código	comp. (mm)
FL0045A	2230
FL0045B	2430
FL0045C	2970



VIGUETA SUPERIOR P/ TAMPA INFERIOR

Código	comp. (mm)
FL0046A	2230
FL0046B	2430
FL0046C	2970



VIGUETA SUPERIOR P/ TAMPA SUPERIOR C/ FURAÇÃO DO ARCO

Código	comp. (mm)
FL0047A	2230
FL0047B	2430
FL0047C	2970



LINHA COLUNAS HORIZON



COLUNA GRADE INFERIOR

Código	comp. (mm)
FL0035EA	700
FL0035FA	800
FL0035CA	900

COLUNA GRADE SUPERIOR

Código	comp. (mm)
FL0033EA	687
FL0033FA	787
FL0033CA	887



COLUNA GRADE INFERIOR COM DOBRADIÇA

Código	comp. (mm)
FL0029EA	700
FL0029FA	800
FL0029CA	900

COLUNA GRADE SUPERIOR COM DOBRADIÇA

Código	comp. (mm)
FL0030EA	687
FL0030FA	787
FL0030CA	887

COMPATÍVEL COM LINHA

LIBRELATO



LINHA CARRETAS ECO+

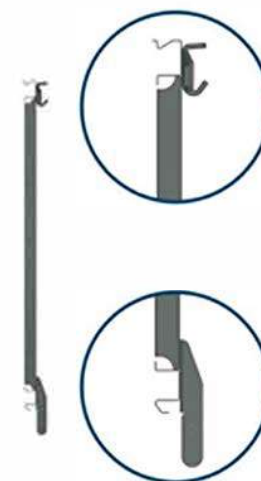

GRADE LATERAL INFERIOR

Código	alt. (mm)	larg. (mm)
FL0007M	800	2230
FL0007N	800	2430
FL0007O	800	2970
FL0007P	900	2230
FL0007Q	900	2430

Código	alt. (mm)	larg. (mm)
FL0007R	900	2970
FL0007S	1000	2230
FL0007T	1000	2430
FL0007U	1000	2970

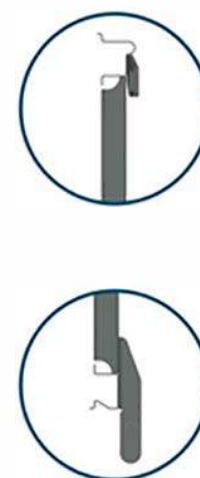

GRADE LATERAL SUPERIOR

Código	alt. (mm)	larg. (mm)
FL0008M	800	2230
FL0008N	800	2430
FL0008O	800	2970
FL0008P	900	2230
FL0008Q	900	2430

Código	alt. (mm)	larg. (mm)
FL0008R	900	2970
FL0008S	1000	2230
FL0008T	1000	2430
FL0008U	1000	2970



COMPATÍVEL COM LINHA

LIBRELATO

LINHA CARRETAS ECO+



GRADE TRASEIRA INFERIOR

Código	alt. (mm)	larg. (mm)
FL0009E	800	2430
FL0009F	900	2430
FL0009G	1000	2430

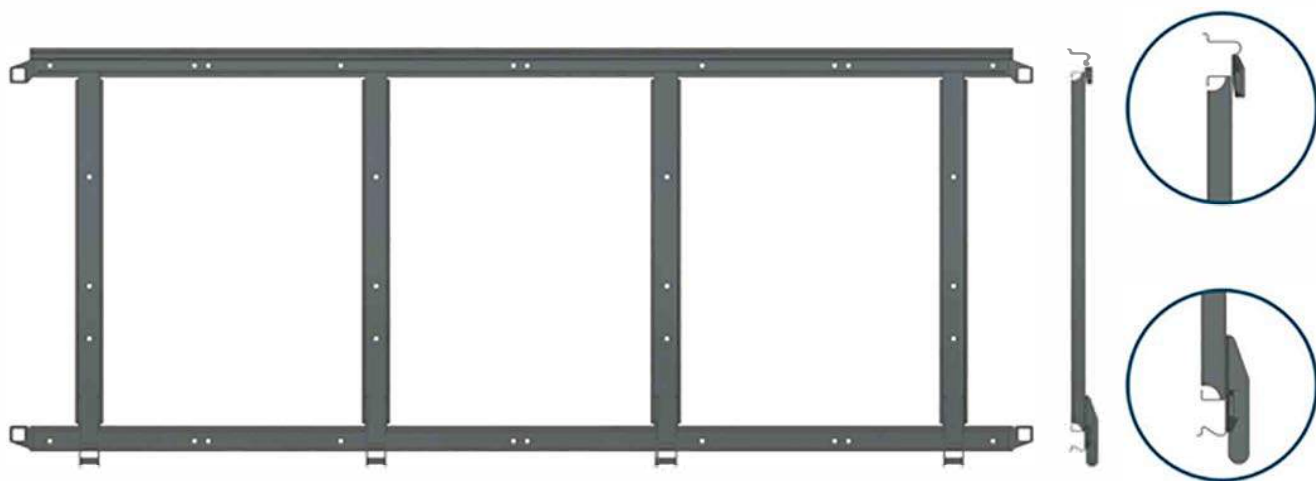

GRADE TRASEIRA SUPERIOR

Código	alt. (mm)	larg. (mm)
FL0011E	800	2430
FL0011F	900	2430
FL0011G	1000	2430

COMPATÍVEL COM LINHA

LIBRELATO



LINHA FUEIROS ECO+

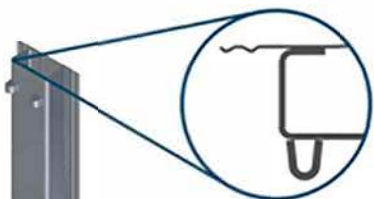

FUEIRO LATERAL INFERIOR

Código	alt. (mm)	larg. (mm)
FL0115E	800	96
FL0115F	900	96
FL0115C	1000	96

FUEIRO LATERAL SUPERIOR

Código	alt. (mm)	larg. (mm)
FL0110E	800	96
FL0110F	900	96
FL0110C	1000	96

FUEIRO DE CANTO INFERIOR DIREITO

Código	alt. (mm)	larg. (mm)
FL0117E	800	96
FL0117F	900	96
FL0117C	1000	96

FUEIRO DE CANTO INFERIOR ESQUERDO

Código	alt. (mm)	larg. (mm)
FL0118E	800	96
FL0118F	900	96
FL0118C	1000	96

FUEIRO DE CANTO SUPERIOR DIREITO

Código	alt. (mm)	larg. (mm)
FL0113E	800	96
FL0113F	900	96
FL0113C	1000	96

FUEIRO DE CANTO SUPERIOR ESQUERDO

Código	alt. (mm)	larg. (mm)
FL0114E	800	96
FL0114F	900	96
FL0114C	1000	96



COMPATÍVEL COM LINHA
LIBRELATO

LINHA FRONTAIS ECO+

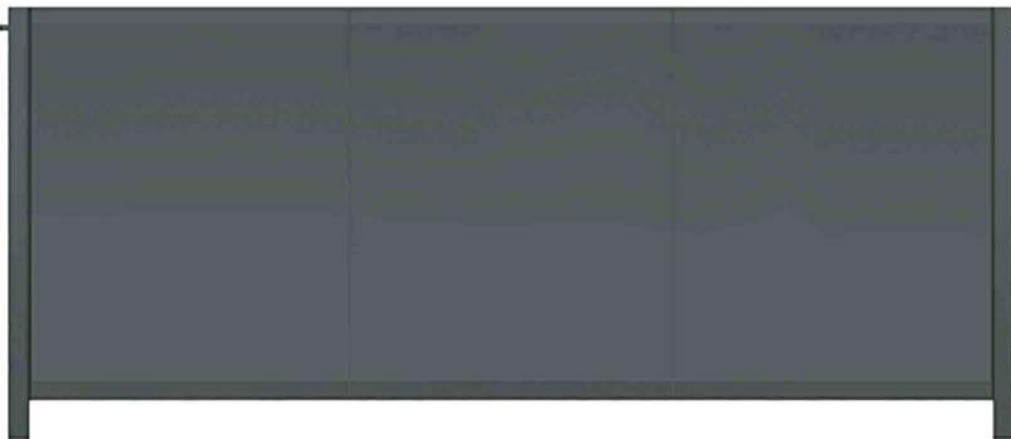

FRONTAL INFERIOR

Código	alt. (mm)
FLO306E	800
FLO306F	900
FLO306G	1000

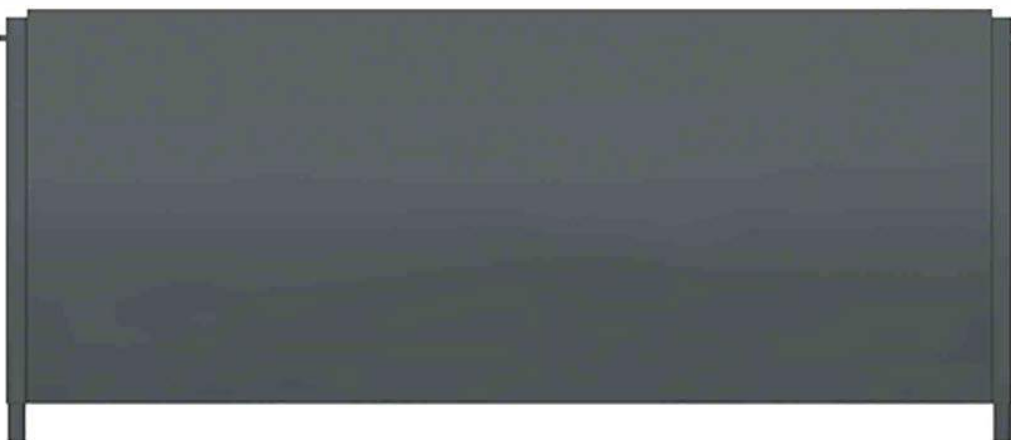

FRONTAL SUPERIOR

Código	alt. (mm)
FLO307E	800
FLO307F	800
FLO307G	1000

COMPATÍVEL COM LINHA

LIBRELATO



LINHA VIGUETAS ECO+

VIGUETA INFERIOR P/ TAMPA INFERIOR

Código	comp. (mm)
FL0039A	2230
FL0039B	2430
FL0039C	2970



VIGUETA INFERIOR P/ TAMPA SUPERIOR

Código	comp. (mm)
FL0041A	2230
FL0041B	2430
FL0041C	2970



VIGUETA SUPERIOR P/ TAMPA INFERIOR

Código	comp. (mm)
FL0042A	2230
FL0042B	2430
FL0042C	2970



VIGUETA SUPERIOR P/ TAMPA SUPERIOR C/ FURAÇÃO DO ARCO

Código	comp. (mm)
FL0044A	2230
FL0044B	2430
FL0044C	2970





COMPATÍVEL COM LINHA

LIBRELATO

LINHA COLUNAS ECO+



COLUNA GRADE INFERIOR E SUPERIOR

Código	comp. (mm)
FL0031EA	687
FL0031FA	787
FL0031GA	887



COLUNA GRADE INFERIOR E SUPERIOR COM DOBRADIÇA

Código	comp. (mm)
FL0032EA	687
FL0032FA	787
FL0032GA	887



FL0010 CONJUNTO TAMPA TRASEIRA INFERIOR ANTIGA/HORIZON E ECO+

COMPATÍVEL COM LINHA

LIBRELATO



DIVERSOS

FL0205A
PERFIL DIANTEIRO
ANTIGO 2430mm



FL0204E
PERFIL LATERAL ANTIGO
HORIZON/ ECO+ 2230mm

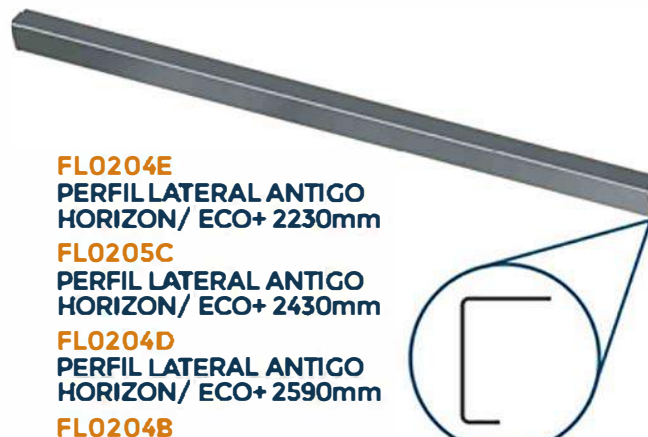

FL0205C
PERFIL LATERAL ANTIGO
HORIZON/ ECO+ 2430mm

FL0204D
PERFIL LATERAL ANTIGO
HORIZON/ ECO+ 2590mm

FL0204B
PERFIL LATERAL ANTIGO
HORIZON/ ECO+ 2970mm

FL205C
PERFIL DIANTEIRO
HORIZON E ECO+
2425mm

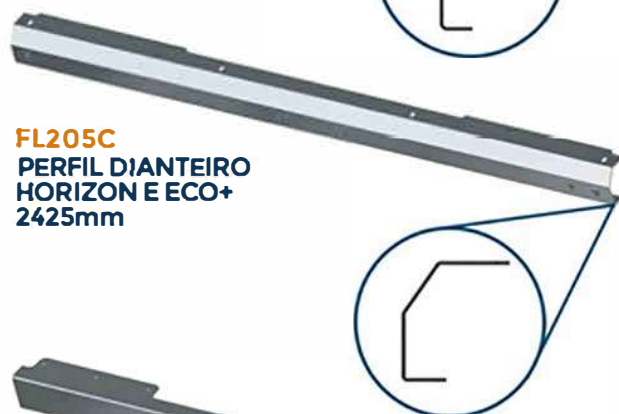

FL0240
RÉGUA DO
PARABARRO 590mm



FL0204A
PERFIL TRASEIRO
ANTIGO 2430mm



FL0250
SUPORTE CENTRAL
DA SAIA 802mm

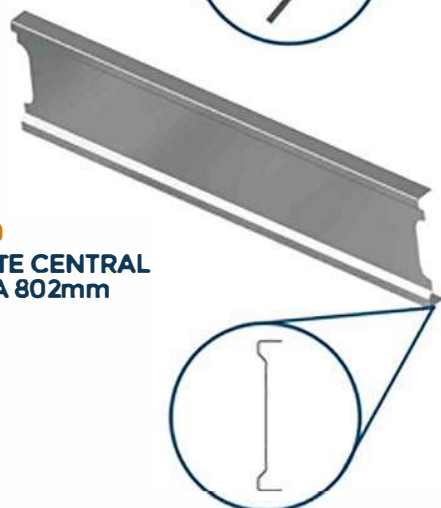

FL0204
PERFIL TRASEIRO
HORIZON E ECO+
2425mm

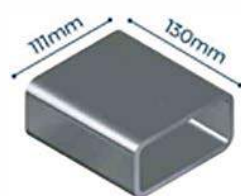

FL0121
CAIXA DO FUEIRO

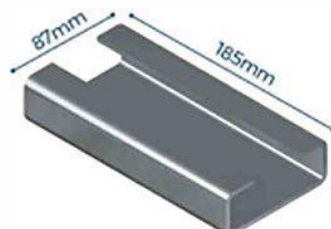

FL0122
ENCAIXE DO FUEIRO



FL0252
SUPORTE PARA
CONEXÃO LIBRELATO



FL0251
SUPORTE DA
PLACA

DIVERSOS

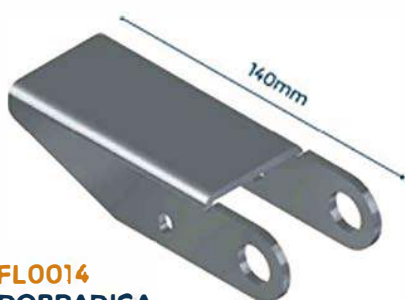

FL0014
DOBRADIÇA
TOMBADOR INFERIOR



FL0026A
DOBRADIÇA
DA TAMPA



FL0018
ROLETE TOMBADOR
TAMPA TRASEIRA



FL0011A
ENGATE TIPO "C"



FL0022
ENGATE FÊMEA
LINHA ANTIGA



FL0022A
ENGATE FÊMEA
HORIZON E ECO+
LADO DIREITO

FL0022B
ENGATE FÊMEA
HORIZON E ECO+
LADO ESQUERDO



FL0039
ARANHA DO
ASSOALHO



FL0015
GANCHO
DO TOMBADOR



FR0016
DESLIZANTE
DO TOMBADOR



FL011ST
TAMPA DO FUEIRO
LIBRELATO (PLÁSTICA)



FL0038T
TAMPA DA VIGUETA
LIBRELATO LE (PLÁSTICA)

FL0039T
TAMPA DA VIGUETA
LIBRELATO LD (PLÁSTICA)



FL0040T
TAMPA DA VIGUETA
LIBRELATO LE (PLÁSTICA)

FL0041T
TAMPA DA VIGUETA
LIBRELATO LD (PLÁSTICA)

COMPATÍVEL COM LINHA

LIBRELATO



LANÇAMENTOS
DIVERSOS



FL0254
SUPORTE SINALEIRA
BITREM LADO DIREITO



FL0254A
SUPORTE SINALEIRA
BITREM LADO ESQUERDO



FL0400
TRAVESSA PASSANTE
2530mm



FL0255
PLACA TRASEIRA
IDENTIFICAÇÃO DE MEDIDAS



COMPATÍVEL COM LINHA

LIBRELATO

LANÇAMENTOS

linha **DOLLY**

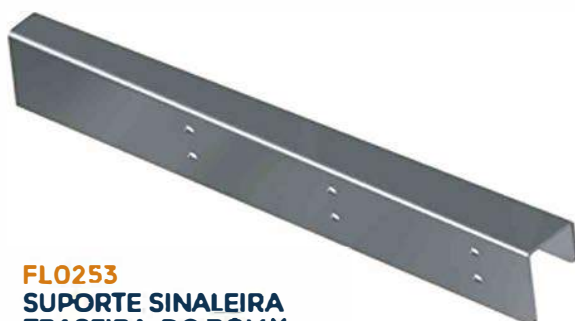

FL0253
SUPORTE SINALEIRA
TRASEIRA DO DOLLY
LADO DIREITO 2013 A 2018



FL0253A
SUPORTE SINALEIRA
TRASEIRA DO DOLLY
LADO ESQUERDO 2013 À 2018

LANÇAMENTOS

linha **BASCULANTES**



FL0903
CATRACA PARA ESTEPE
DA BASCULANTE LADO
DIREITO



FL0902
TRAVA TAMPA BASCULANTE



FL0900
DOBRADIÇA
BASCULANTE

PEÇAS COMPATÍVEIS COM

linha NOMA

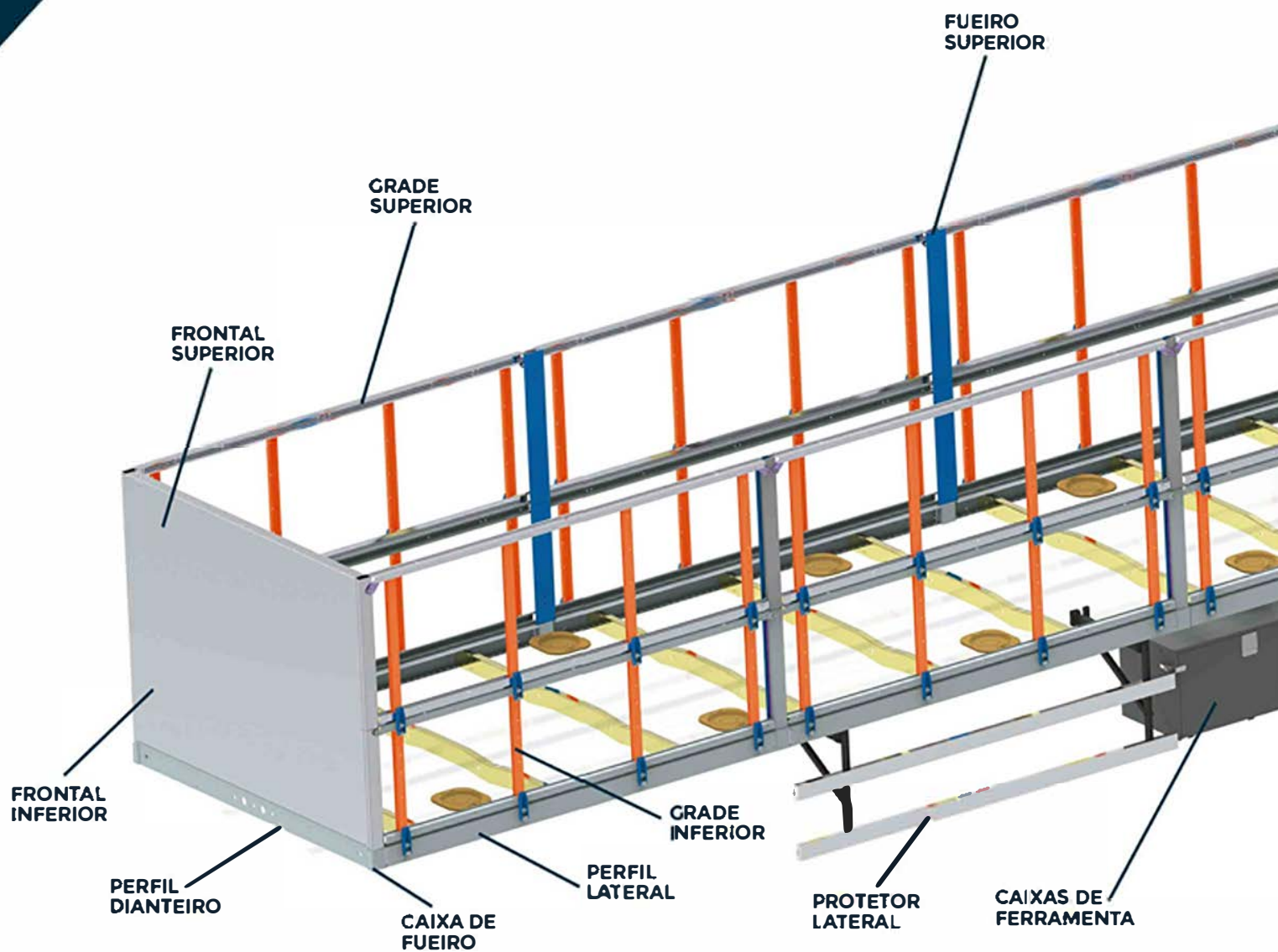

FUEIRO DE CANTO SUPERIOR

PERFIL TRASEIRO

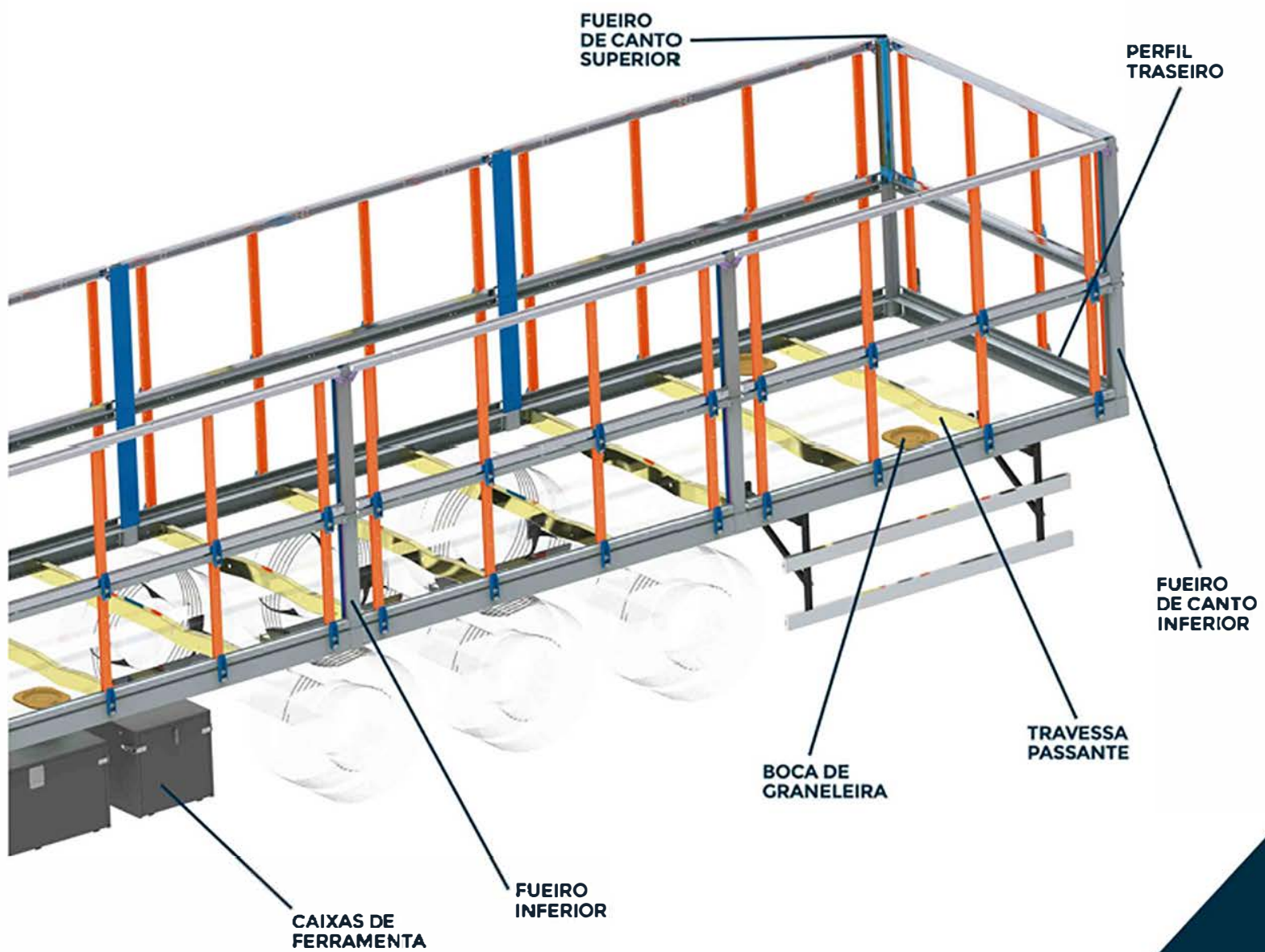

FUEIRO DE CANTO INFERIOR

BOCA DE GRANELEIRA

TRAVESSA PASSANTE

CAIXAS DE FERRAMENTA

FUEIRO INFERIOR



COMPATÍVEL COM LINHA

NOMA



LINHA CARRETAS FÊNIX

A PARTIR DE 2014

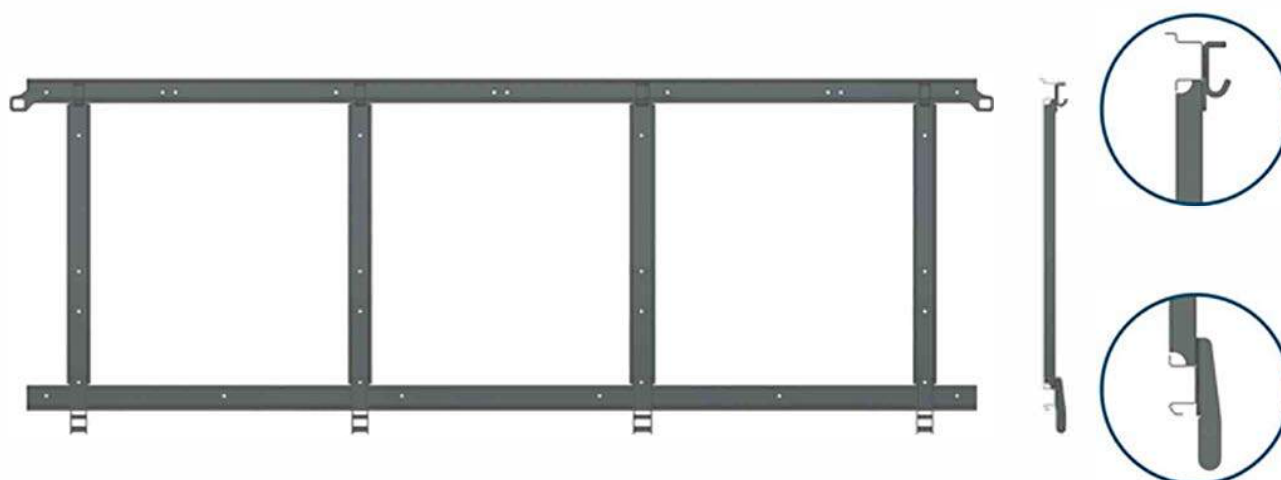

GRADE LATERAL INFERIOR

Código	alt. (mm)	larg. (mm)	Código	alt. (mm)	larg. (mm)
FN0001H	640	2217	FN0001Q	890	2217
FN0001J	640	2365	FN0001R	890	2365
FN0001L	640	2865	FN0001T	890	2865
FN0001M	790	2217	FN0001U	990	2217
FN0001N	790	2365	FN0001V	990	2365
FN0001P	790	2865	FN0001Z	990	2865

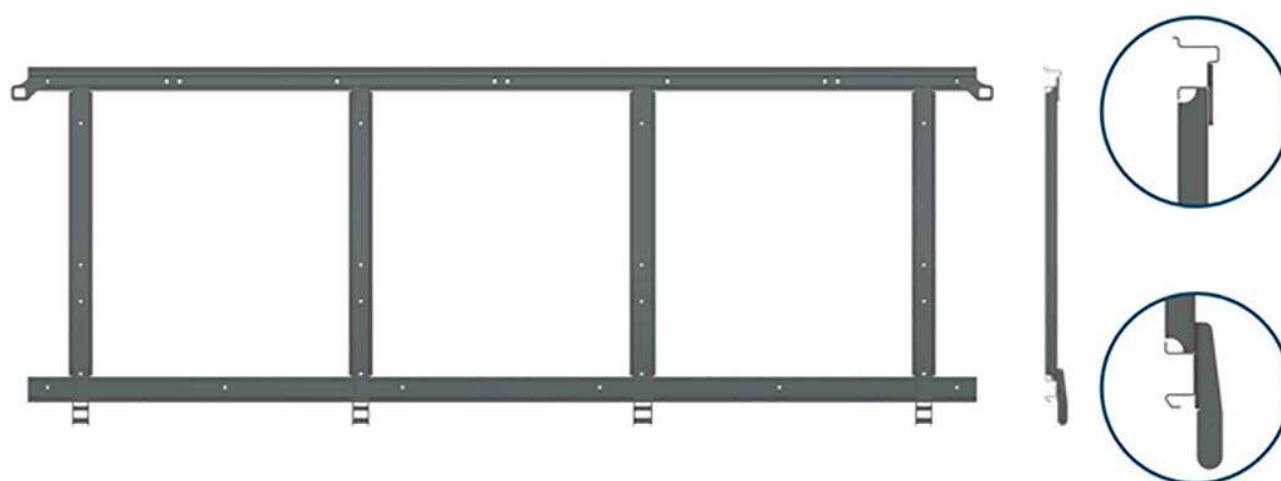

GRADE LATERAL SUPERIOR

Código	alt. (mm)	larg. (mm)	Código	alt. (mm)	larg. (mm)
FN0002I	653	2217	FN0002Q	903	2217
FN0002J	653	2365	FN0002R	903	2365
FN0002L	653	2865	FN0002T	903	2865
FN0002M	803	2217	FN0002U	1003	2217
FN0002N	803	2365	FN0002V	1003	2365
FN0002P	803	2865	FN0002Z	1003	2865

LINHA CARRETAS FÊNIX

A PARTIR DE 2014

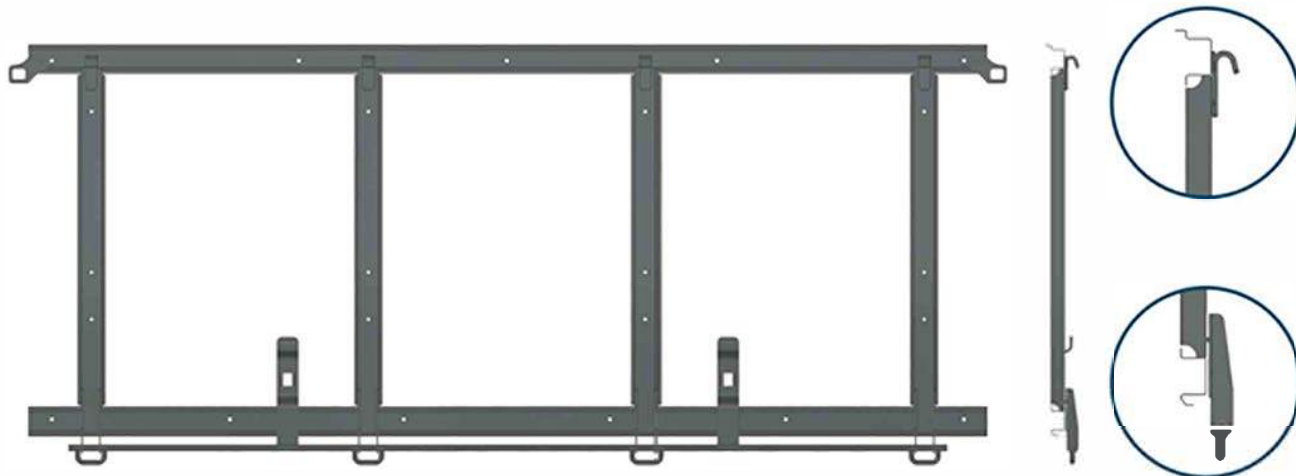

GRADE TRASEIRA INFERIOR

Código	alt. (mm)	larg. (mm)
FN0004C	640	2445
FN0004D	790	2445
FN0004E	890	2445
FN0004F	990	2445

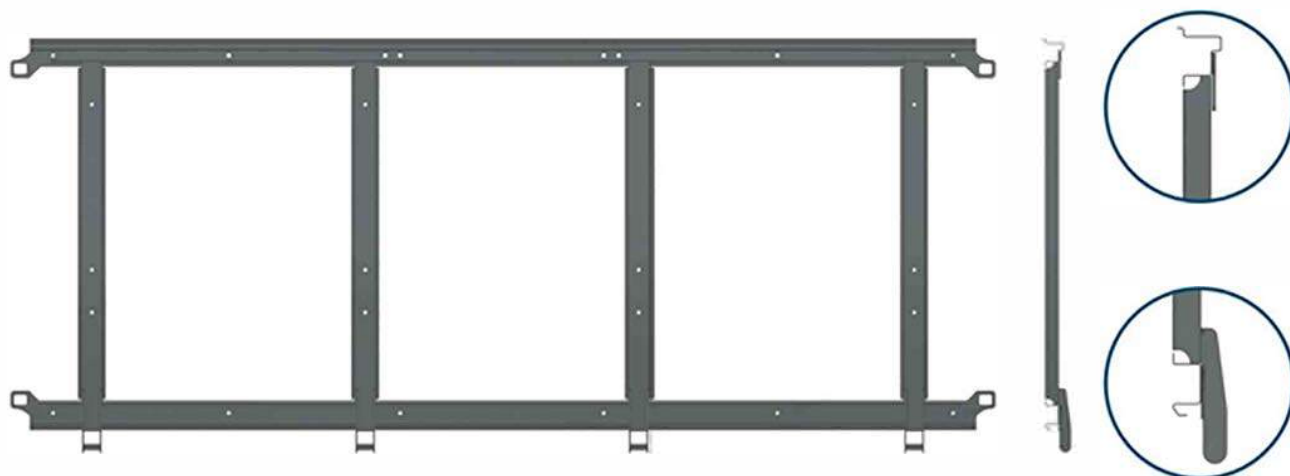

GRADE TRASEIRA SUPERIOR

Código	alt. (mm)	larg. (mm)
FN0005C	653	2445
FN0005D	803	2445
FN0005E	903	2445
FN0005F	1003	2445

COMPATÍVEL COM LINHA

NOMA



LINHA FUEIROS FÊNIX

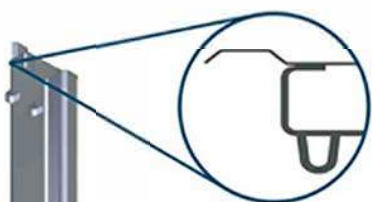

FUEIRO LATERAL INFERIOR

Código	alt. (mm)	larg. (mm)
FN0103C	640	96
FN0103D	790	96
FN0103E	890	96
FN0103F	990	96

FUEIRO LATERAL SUPERIOR

Código	alt. (mm)	larg. (mm)
FN0104C	653	96
FN0104D	803	96
FN0104E	903	96
FN0104F	1003	96

FUEIRO DE CANTO INFERIOR DIREITO

Código	alt. (mm)	larg. (mm)
FN0105C	640	96
FN0105D	790	96
FN0105E	890	96
FN0105F	990	96

FUEIRO DE CANTO INFERIOR ESQUERDO

Código	alt. (mm)	larg. (mm)
FN0106C	640	96
FN0106D	790	96
FN0106E	890	96
FN0106F	990	96

FUEIRO DE CANTO SUPERIOR DIREITO

Código	alt. (mm)	larg. (mm)
FN0107C	653	96
FN0107D	803	96
FN0107E	903	96
FN0107F	1003	96

FUEIRO DE CANTO SUPERIOR ESQUERDO

Código	alt. (mm)	larg. (mm)
FN0108C	653	96
FN0108D	803	96
FN0108E	903	96
FN0108F	1003	96



COMPATÍVEL COM LINHA

NOMA

LINHA FRONTAIS FÊNIX

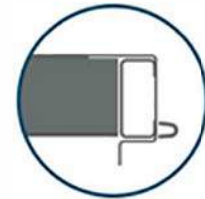

FRONTAL INFERIOR

Código	alt. (mm)
FN0300C	640
FN0300D	790
FN0300E	890
FN0300F	990

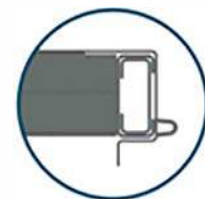
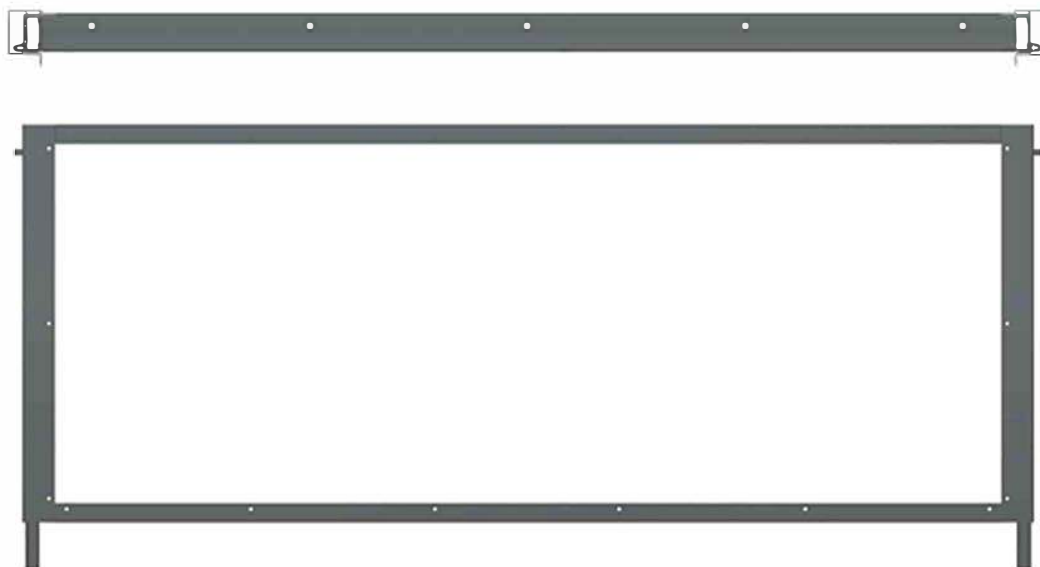

FRONTAL SUPERIOR

Código	alt. (mm)
FN0301C	653
FN0301D	803
FN0301E	903
FN0301F	1003

COMPATÍVEL COM LINHA

NOMA



LINHA CARRETAS TITANIUM

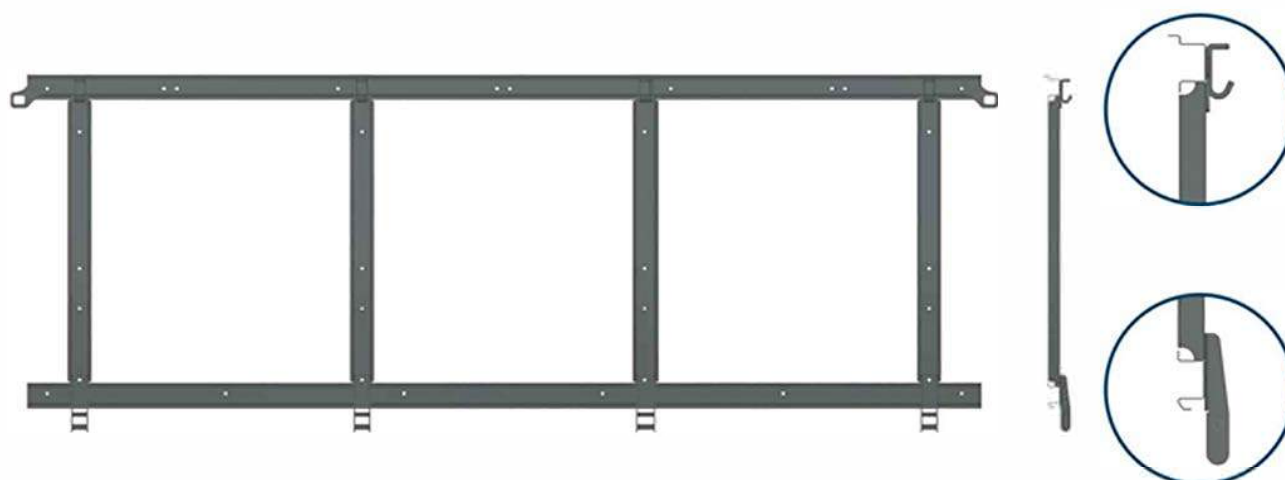

GRADE LATERAL INFERIOR

Código	alt. (mm)	larg. (mm)	Código	alt. (mm)	larg. (mm)
FN0001H	640	2217	FN0001Q	890	2217
FN0001J	640	2365	FN0001R	890	2365
FN0001L	640	2865	FN0001T	890	2865
FN0001M	790	2217	FN0001U	990	2217
FN0001N	790	2365	FN0001V	990	2365
FN0001P	790	2865	FN0001Z	990	2865

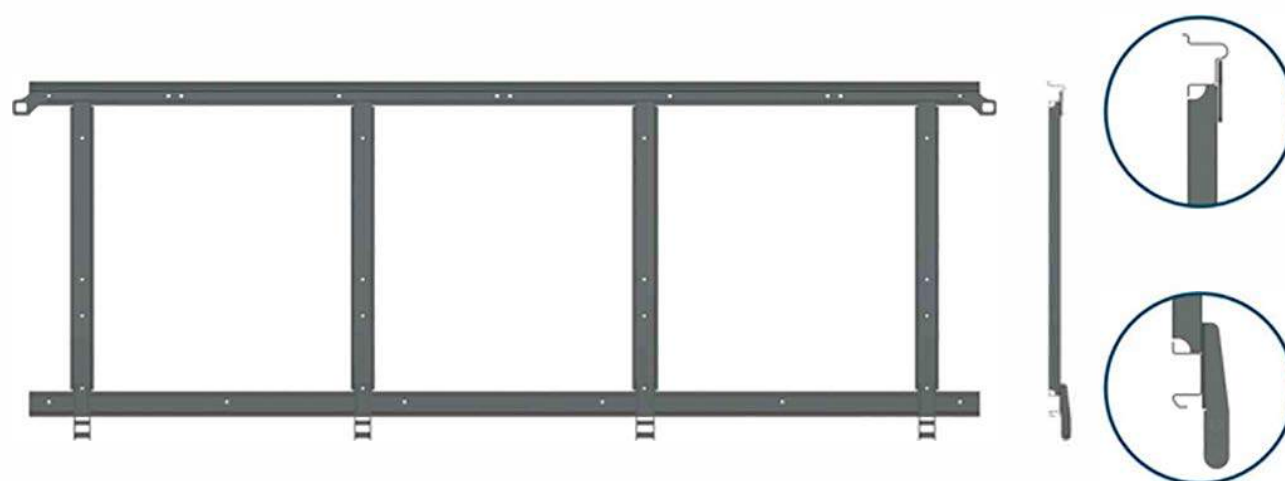

GRADE LATERAL SUPERIOR

Código	alt. (mm)	larg. (mm)	Código	alt. (mm)	larg. (mm)
FN0007I	653	2217	FN0007Q	903	2217
FN0007J	653	2365	FN0007R	903	2365
FN0007L	653	2865	FN0007T	903	2865
FN0007M	803	2217	FN0007U	1003	2217
FN0007N	803	2365	FN0007V	1003	2365
FN0007P	803	2865	FN0007Z	1003	2865

LINHA CARRETAS TITANIUM



GRADE TRASEIRA INFERIOR

Código	alt. (mm)	larg. (mm)
FN0004C	640	2445
FN0004D	790	2445
FN0004E	890	2445
FN0004F	990	2445

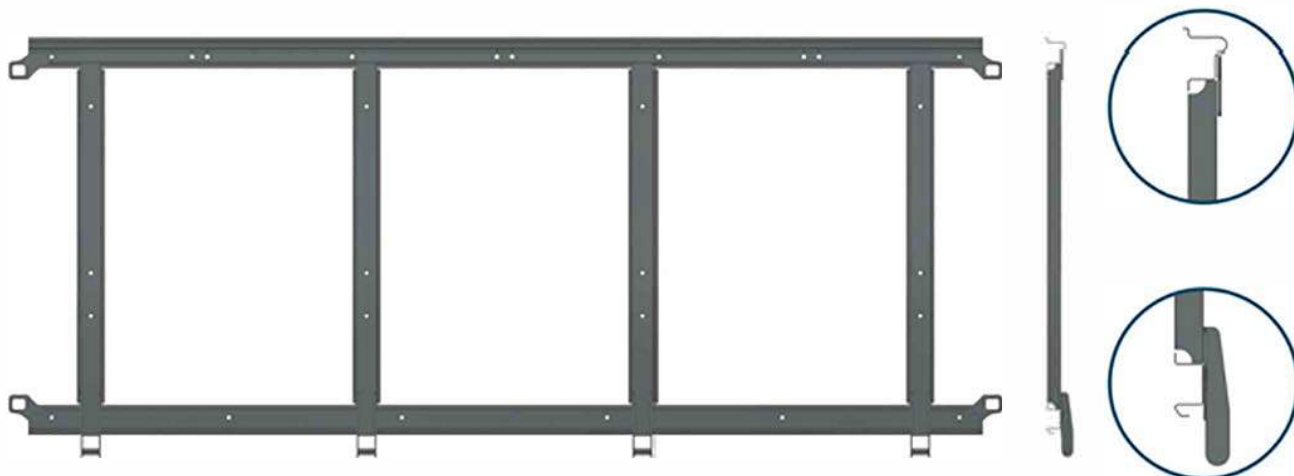

GRADE TRASEIRA SUPERIOR

Código	alt. (mm)	larg. (mm)
FN0009C	653	2445
FN0009D	803	2445
FN0009E	903	2445
FN0009F	1003	2445



FN0010 CONJUNTO TAMPA TRASEIRA

COMPATÍVEL COM LINHA

NOMA



LINHA FUEIROS TITANIUM

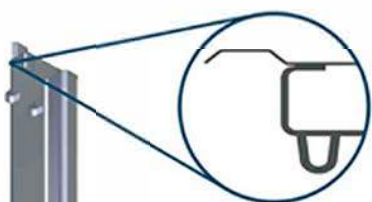

FUEIRO LATERAL INFERIOR

Código	alt. (mm)	larg. (mm)
FN0103C	640	96
FN0103D	790	96
FN0103E	890	96
FN0103F	990	96

FUEIRO LATERAL SUPERIOR

Código	alt. (mm)	larg. (mm)
FN0104C	653	96
FN0104D	803	96
FN0104E	903	96
FN0104F	1003	96

FUEIRO DE CANTO INFERIOR DIREITO

Código	alt. (mm)	larg. (mm)
FN0105C	640	96
FN0105D	790	96
FN0105E	890	96
FN0105F	990	96

FUEIRO DE CANTO INFERIOR ESQUERDO

Código	alt. (mm)	larg. (mm)
FN0106C	640	96
FN0106D	790	96
FN0106E	890	96
FN0106F	990	96

FUEIRO DE CANTO SUPERIOR DIREITO

Código	alt. (mm)	larg. (mm)
FN0107C	653	96
FN0107D	803	96
FN0107E	903	96
FN0107F	1003	96

FUEIRO DE CANTO SUPERIOR ESQUERDO

Código	alt. (mm)	larg. (mm)
FN0108C	653	96
FN0108D	803	96
FN0108E	903	96
FN0108F	1003	96



COMPATÍVEL COM LINHA

NOMA

LINHA FRONTAIS TITANIUM

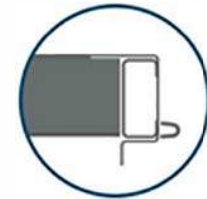

FRONTAL INFERIOR

Código	alt. (mm)
FN0300C	640
FN0300D	790
FN0300E	890
FN0300F	990

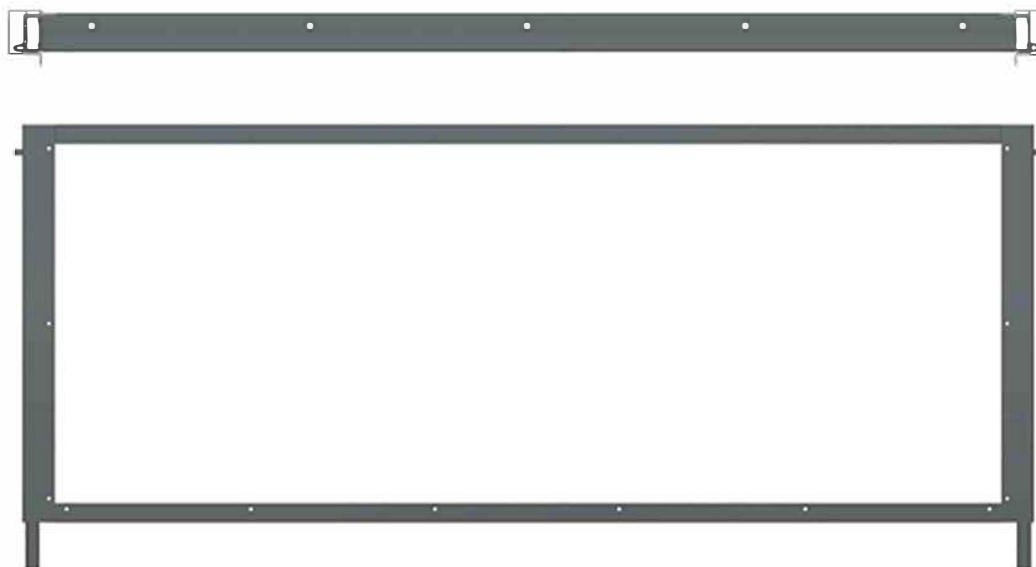

FRONTAL SUPERIOR

Código	alt. (mm)
FN0301C	653
FN0301D	803
FN0301E	903
FN0301F	1003

COMPATÍVEL COM LINHA

NOMA



DIVERSOS

VIGUETA SUPERIOR P/ TAMPA SUPERIOR C/ FURAÇÃO DO ARCO FÊNIX

Código	comp. (mm)
FN0043A	2217
FN0043B	2365
FN0043C	2445
FN0043D	2865

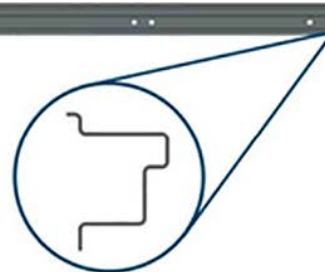

VIGUETA SUPERIOR P/ TAMPA SUPERIOR C/ FURAÇÃO DO ARCO TITANIUM

Código	comp. (mm)
FN0044A	2217
FN0044B	2365
FN0044C	2445
FN0044D	2865

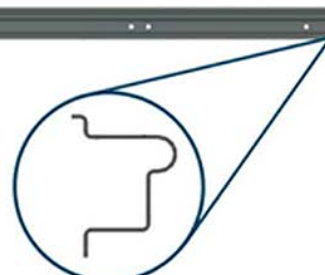

VIGUETA SUPERIOR P/ TAMPA INFERIOR

Código	comp. (mm)
FN0040A	2217
FN0040B	2365
FN0040C	2445
FN0040D	2865

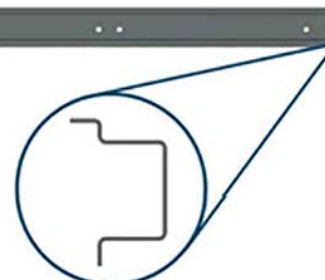

VIGUETA INFERIOR P/ TAMPA INFERIOR E SUPERIOR

Código	comp. (mm)
FN0038A	2217
FN0038B	2365
FN0038C	2445
FN0038D	2865

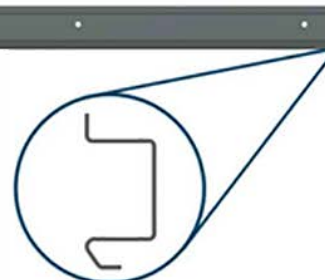

COLUNA INFERIOR

Código	comp. (mm)	Código	comp. (mm)
FN0035CA	525	FN0035EA	775
FN0035DA	675	FN0035FA	875

COLUNA SUPERIOR

Código	comp. (mm)	Código	comp. (mm)
FN0033CA	538	FN0033EA	788
FN0033DA	688	FN0033FA	888



COMPATÍVEL COM LINHA

NOMA

DIVERSOS

FN0205
PERFIL DIANTEIRO
FÊNIX 2445mm



FN0205A
PERFIL DIANTEIRO
FÊNIX ABS 2445mm



FN0205B
PERFIL DIANTEIRO
TITANIUM 2445mm



FN0204I
PERFIL LATERAL
FÊNIX 2217mm



FN0204H
PERFIL LATERAL
FÊNIX 2365mm

FN0204F
PERFIL LATERAL
FÊNIX 2865mm

FN0204
PERFIL TRASEIRO
TITANIUM 2445mm



FN0204A
PERFIL TRASEIRO
FÊNIX 2445mm



FN0206A
PERFIL LATERAL PARA
ASSOALHO DE FERRO 2217mm

FN0206B
PERFIL LATERAL PARA
ASSOALHO DE FERRO
2365mm

FN0206C
PERFIL LATERAL
PARA ASSOALHO
DE FERRO 2865mm



FN0206D
PERFIL TRASEIRO
PARA ASSOALHO DE
FERRO 2445mm



FN0204E
PERFIL LATERAL
TITANIUM 2217mm

FN0204D
PERFIL LATERAL
TITANIUM 2365mm

FN0204B
PERFIL LATERAL
TITANIUM 2865mm



COMPATÍVEL COM LINHA

NOMA



DIVERSOS



FN0026
DOBRADIÇA DA TAMPA

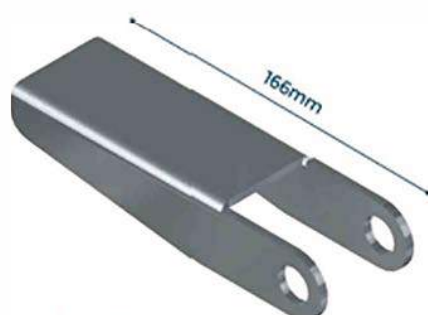

FN0014
DOBRADIÇA DO
TOMBADOR INFERIOR

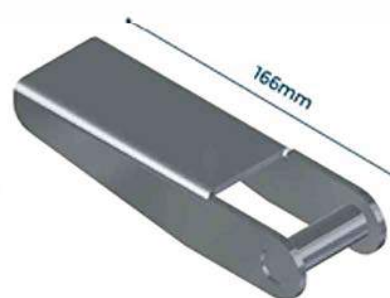

FN0017
DOBRADIÇA DO
TOMBADOR SUPERIOR



FN0026A
DOBRADIÇA NOMA
FÊNIX 2012 200mm



FN0011A
ENGATE "G"
FÊNIX



FN0020
ENGATE FÊMEA
INFERIOR E
SUPERIOR



FR0016
DESLIZANTE
DO TOMBADOR



FN0015B
TRAVA DO
TOMBADOR



FN0015
GANCHO DO
TOMBADOR

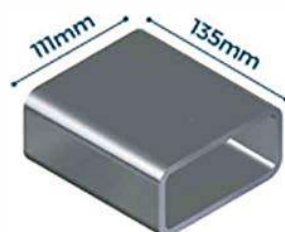

FN0121
CAIXA DO FUEIRO

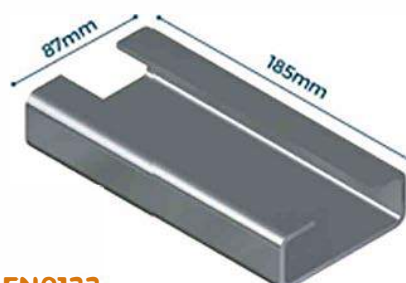

FN0122
ENCAIXE DO FUEIRO



COMPATÍVEL COM LINHA

NOMA

DIVERSOS



FN0250
SUPORTE CENTRAL
DA SAIA FENIX 815mm



FN0252
SUPORTE PARA
CONEXÃO FENIX



FN0038T
TAMPA DA VIGUETA NOMA
(PLÁSTICA)



FN0115T
TAMPA DO FUEIRO
NOMA (PLÁSTICA)

LANÇAMENTOS

linha **DOLLY**



FN0253
SUPORTE SINALEIRA
DO DOLLY LD/LE
NOMA FENIX

PEÇAS COMPATÍVEIS COM

linha FACCHINI

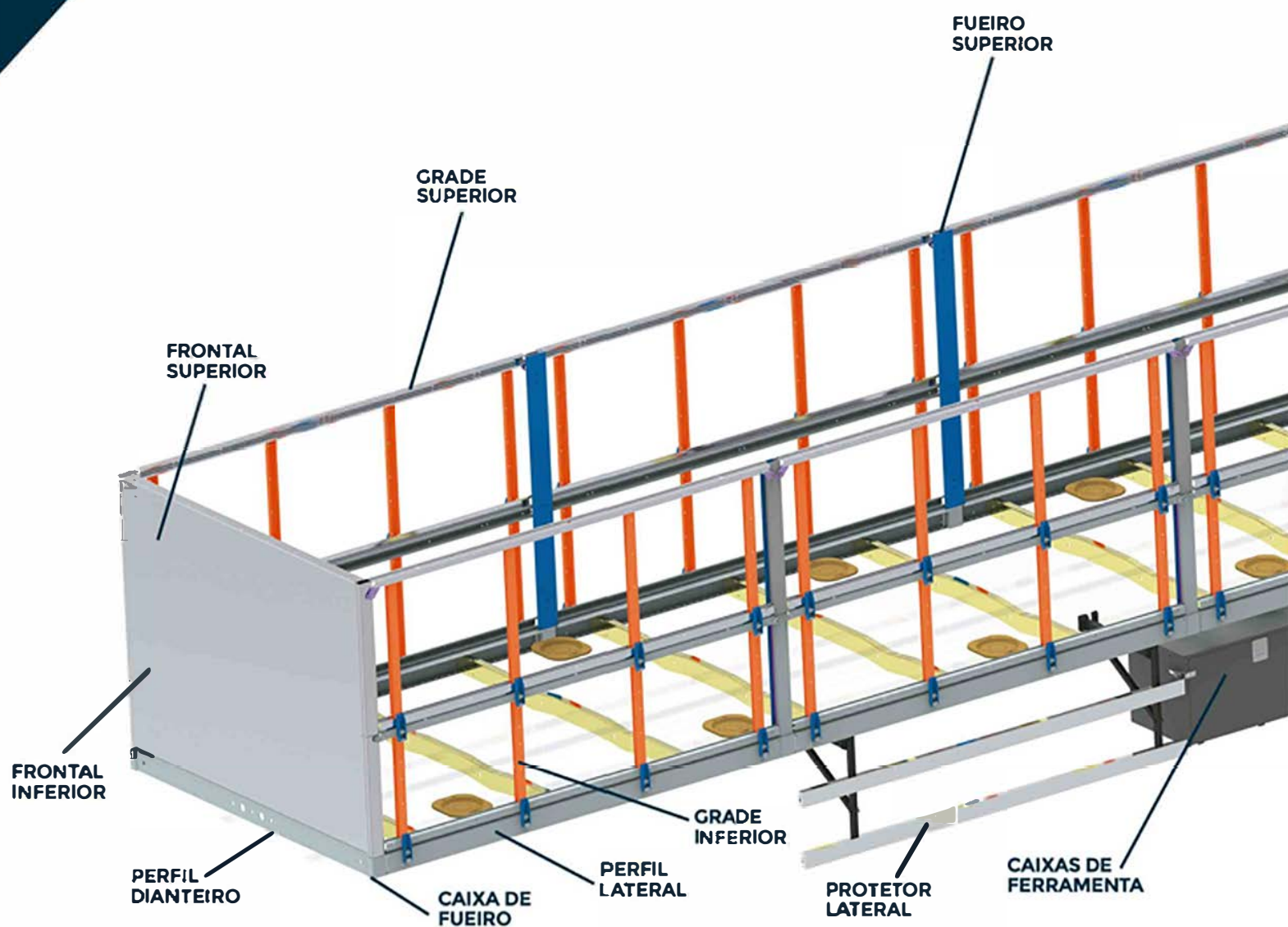

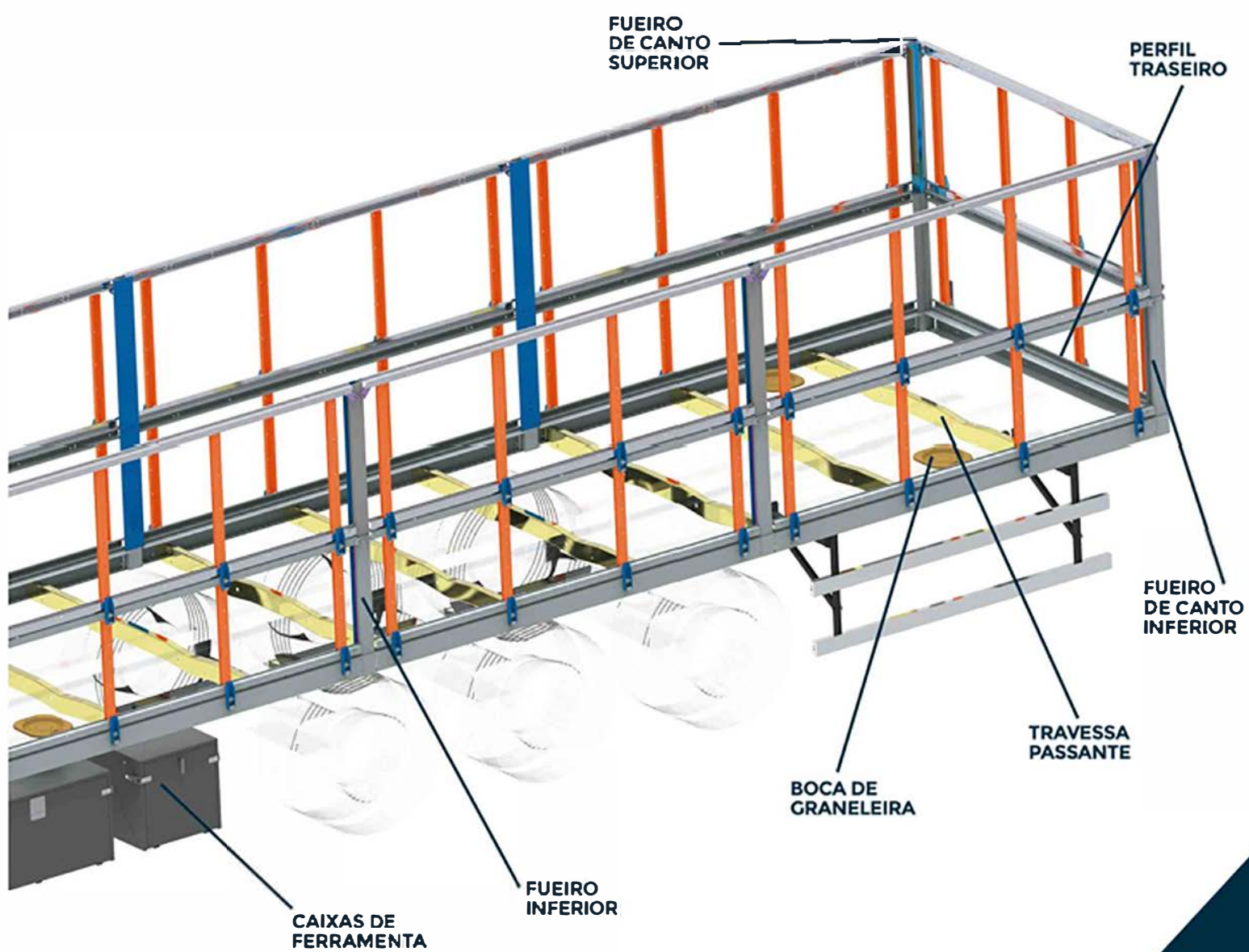

COMPATÍVEL COM LINHA

FACCHINI



LANÇAMENTOS

LINHA FRONTAIS NOVOS



FRONTAL INFERIOR (FUEIROS COM 124mm)

Código	alt. (mm)	larg. (mm)
FF0304A	530	124
FF0304B	580	124
FF0304C	630	124
FF0304D	680	124

Código	alt. (mm)	larg. (mm)
FF0304E	780	124
FF0304F	880	124
FF0304G	980	124

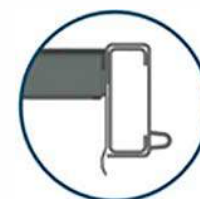

FRONTAL SUPERIOR (FUEIROS COM 124mm)

Código	alt. (mm)	larg. (mm)
FF0305A	550	124
FF0305B	600	124
FF0305C	650	124
FF0305D	700	124

Código	alt. (mm)	larg. (mm)
FF0305E	800	124
FF0305F	900	124
FF0305G	1000	124

LANÇAMENTOS

LINHA FUEIROS NOVOS



FUEIRO LATERAL INFERIOR

Código	alt. (mm)	larg. (mm)
FF0103A	550	124
FF0103B	600	124
FF0103C	650	124
FF0103D	700	124
FF0103E	800	124
FF0103F	900	124
FF0103G	1000	124



FUEIRO LATERAL SUPERIOR

Código	alt. (mm)	larg. (mm)
FF0104A	550	124
FF0104B	600	124
FF0104C	650	124
FF0104D	700	124
FF0104E	800	124
FF0104F	900	124
FF0104G	1000	124



FUEIRO DE CANTO INFERIOR DIREITO

Código	alt. (mm)	larg. (mm)
FF0105A	550	124
FF0105B	600	124
FF0105C	650	124
FF0105D	700	124
FF0105E	800	124
FF0105F	900	124
FF0105G	1000	124



FUEIRO DE CANTO INFERIOR ESQUERDO

Código	alt. (mm)	larg. (mm)
FF0106A	550	124
FF0106B	600	124
FF0106C	650	124
FF0106D	700	124
FF0106E	800	124
FF0106F	900	124
FF0106G	1000	124



FUEIRO DE CANTO SUPERIOR DIREITO

Código	alt. (mm)	larg. (mm)
FF0107A	550	124
FF0107B	600	124
FF0107C	650	124
FF0107D	700	124
FF0107E	800	124
FF0107F	900	124
FF0107G	1000	124



FUEIRO DE CANTO SUPERIOR ESQUERDO

Código	alt. (mm)	larg. (mm)
FF0108A	550	124
FF0108B	600	124
FF0108C	650	124
FF0108D	700	124
FF0108E	800	124
FF0108F	900	124
FF0108G	1000	124

COMPATÍVEL COM LINHA

FACCHINI



LANÇAMENTOS

LINHA VIGUETAS

COLONAS PARA TAMPAS ALUPLAST

VIGUETA INFERIOR P/ TAMPA INFERIOR E SUPERIOR

Código	comp. (mm)
FF0038A	2220
FF0038B	2435
FF0038C	2535
FF0038D	2590
FF0038E	2970

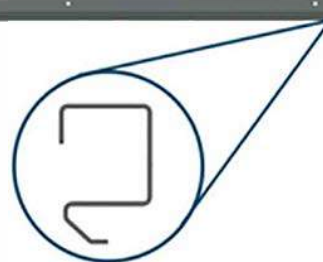

VIGUETA SUPERIOR P/ TAMPA INFERIOR

Código	comp. (mm)
FF0040A	2220
FF0040B	2435
FF0040C	2535
FF0040D	2590
FF0040E	2970

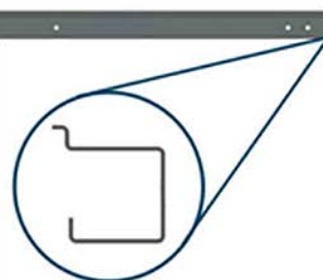

VIGUETA SUPERIOR P/ TAMPA SUPERIOR

Código	comp. (mm)
FF0043A	2220
FF0043B	2435
FF0043C	2535
FF0043D	2590
FF0043E	2970

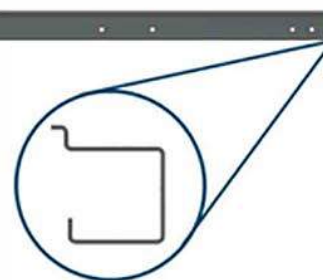

VIGUETA INFERIOR P/ TAMPA SUPERIOR TRASEIRA

Código	comp. (mm)
FF0044	2435

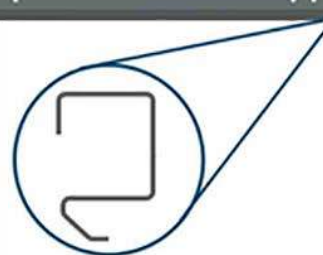

COLUNA INFERIOR E SUPERIOR

Código	comp. (mm)	Código	comp. (mm)
FF0027AA	440	FF0027EA	690
FF0027BA	490	FF0027FA	790
FF0027CA	540	FF0027GA	890
FF0027DA	590		

LANÇAMENTOS

LINHA VIGUETAS

COLUNAS PARA TAMPAS DE MADEIRA

VIGUETA INFERIOR P/ TAMPA INFERIOR E SUPERIOR

Código	comp. (mm)
FF0039A	2220
FF0039B	2435
FF0039C	2535
FF0039D	2590
FF0039E	2970

VIGUETA SUPERIOR P/ TAMPA INFERIOR

Código	comp. (mm)
FF0042A	2220
FF0042B	2435
FF0042C	2535
FF0042D	2590
FF0042E	2970

VIGUETA SUPERIOR P/ TAMPA SUPERIOR

Código	comp. (mm)
FF0045A	2220
FF0045B	2435
FF0045C	2535
FF0045D	2590
FF0045E	2970

VIGUETA INFERIOR P/ TAMPA SUPERIOR TRASEIRA

Código	comp. (mm)
FF0046	2435

COLUNA INFERIOR E SUPERIOR

Código	comp. (mm)	Código	comp. (mm)
FF0033AA	440	FF0033EA	690
FF0033BA	490	FF0033FA	790
FF0033CA	540	FF0033GA	890
FF0033DA	590		

COMPATÍVEL COM LINHA

FACCHINI



LANÇAMENTOS DIVERSOS

FF0205A
PERFIL DIANTEIRO
2435mm (PARA ASSOALHO
DE FERRO E COMPENSADO)



FF0204
PERFIL TRASEIRO
2435mm (PARA ASSOALHO
DE FERRO)



FF204A
PERFIL TRASEIRO
2435mm (PARA ASSOALHO
DE COMPENSADO)



**PERFIL LATERAL
(PARA ASSOALHO
DE FERRO)**

Código	larg. (mm)
FF0204B	2220
FF0204C	2435
FF0204D	2540
FF0204E	2590
FF0204F	2970

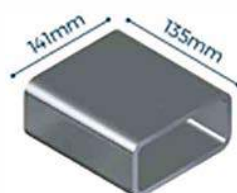

FF0121A
CAIXA DO FUEIRO
(PARA FUEIROS
124mm)

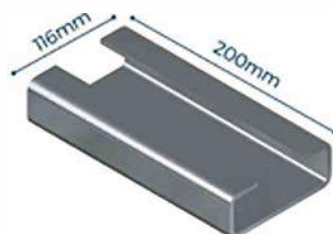

FF0122A
ENCAIXE DO FUEIRO
(PARA FUEIROS
124mm)

**PERFIL LATERAL
(PARA ASSOALHO
DE COMPENSADO)**

Código	larg. (mm)
FF0204G	2220
FF0204H	2435
FF0204I	2540
FF0204J	2590
FF0204K	2970

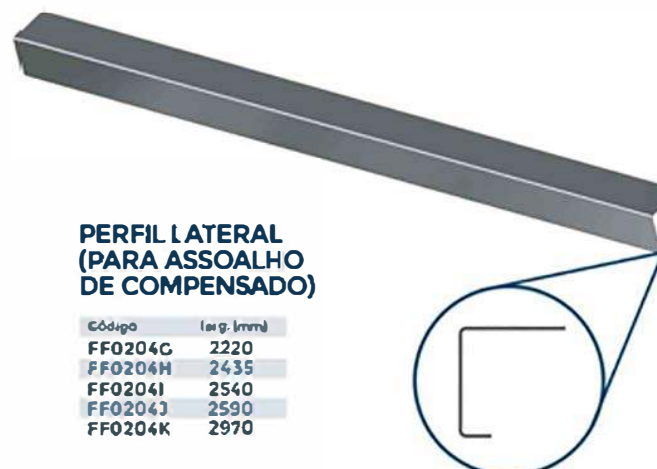

**LANÇAMENTOS
DIVERSOS**



FF0026
DOBRADIÇA
DA TAMPA



FF0014
DOBRADIÇA DO
TOMBADOR INFERIOR



FF0017
DOBRADIÇA DO
TOMBADOR SUPERIOR



FF0015
GANCHO TOMBADOR



FF0011A
ENGATERÁPIDO
TIPO "G"



FF0020A
ENGATE FÊMEA
INFERIOR E SUPERIOR



FF0020
ENGATE FÊMEA
155mm FACCHINI



FF0020C
ENGATE FÊMEA
INFERIOR 205mm
FACCHINI



FF0020B
ENGATE FÊMEA
SUPERIOR 205mm
FACCHINI



FF0010
CONJUNTO TAMPA
TRASEIRA INFERIOR

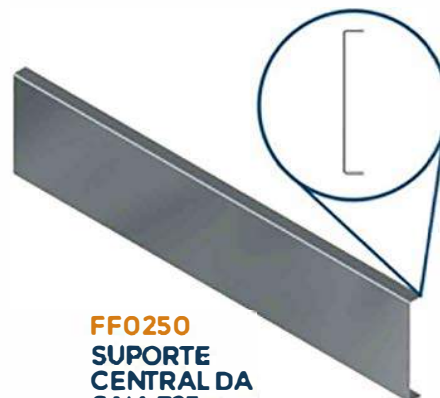

FF0250
SUPORTE
CENTRAL DA
SAJA 725mm

COMPATÍVEL COM LINHA

FACCHINI



LANÇAMENTOS

linha **SIDER**

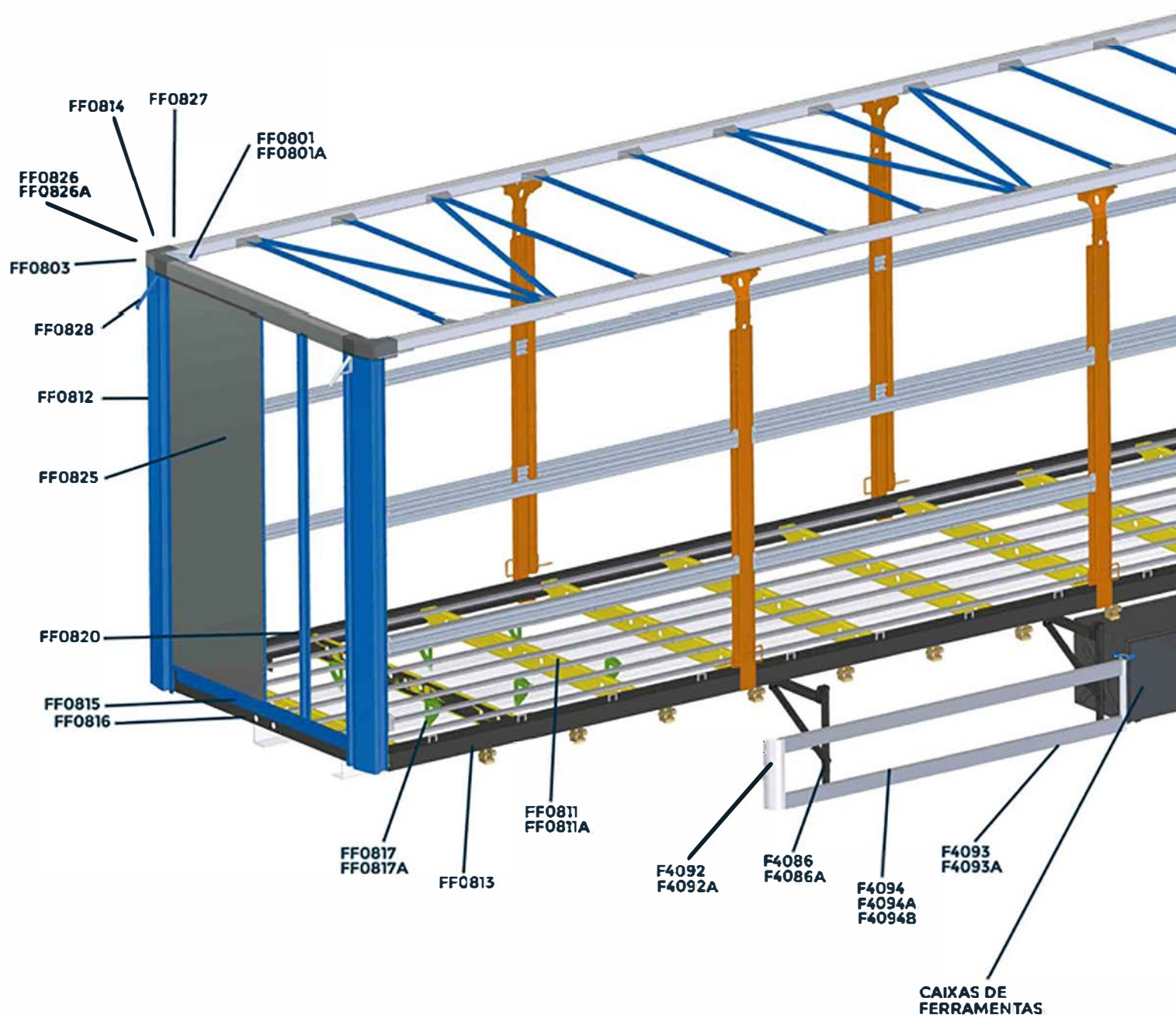



COMPATÍVEL COM LINHA

FACCHINI

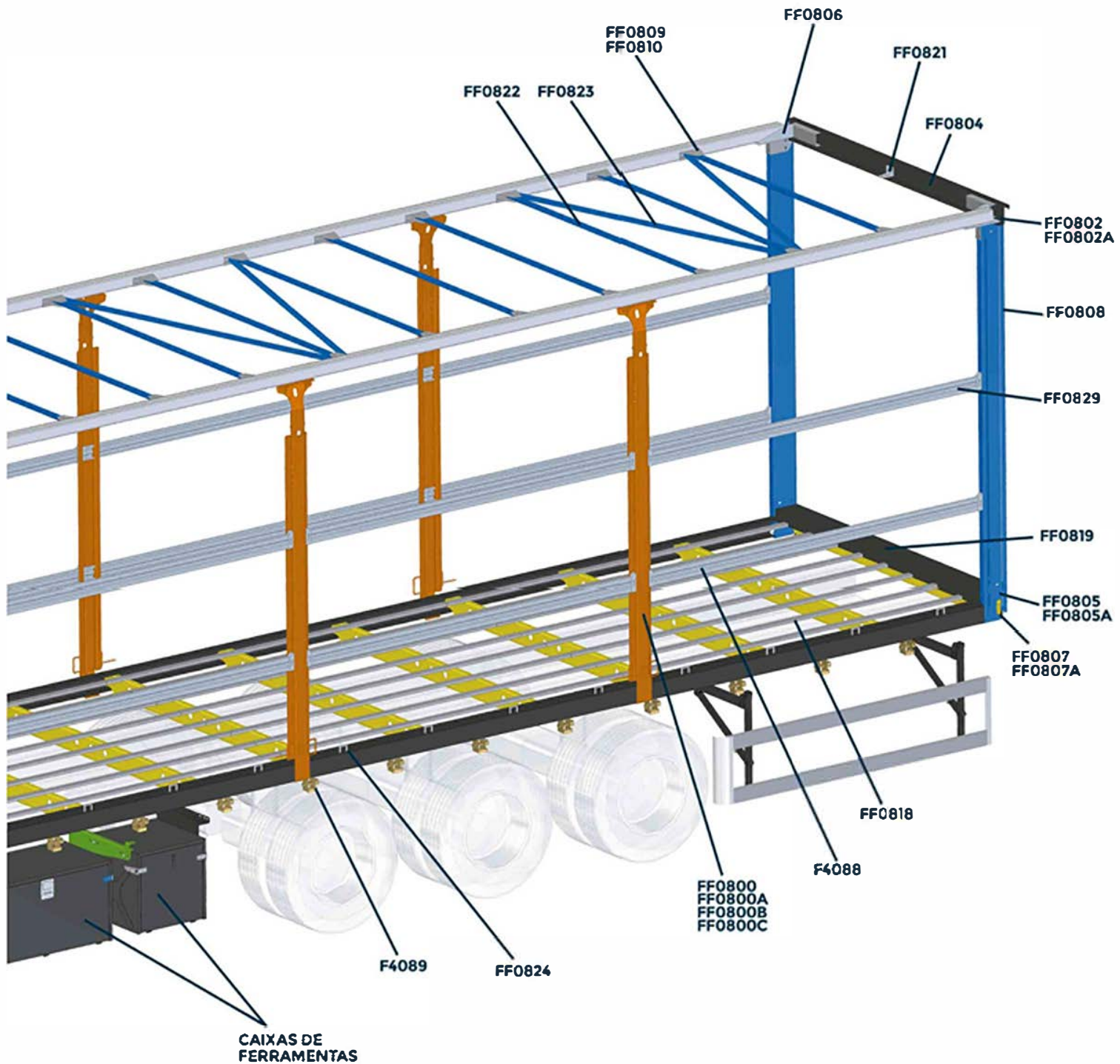

COMPATÍVEL COM LINHA

FACCHINI



LANÇAMENTOS

COMPATÍVEIS LINHA SIDER



FF0801
SUPORTE DE FIXAÇÃO DA
COLUNA SIDER SUPERIOR
LADO DIREITO FACCHINI

FF0801A
SUPORTE DE FIXAÇÃO DA
COLUNA SIDER SUPERIOR
LADO ESQUERDO FACCHINI



FF0827
ACABAMENTO
SUPERIOR DO FRONTAL
SIDER FACCHINI 2250mm

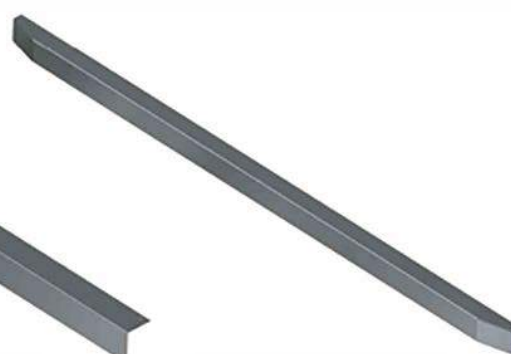

FF0814
PERFIL SUPERIOR
DO FRONTAL SIDER
FACCHINI 2580mm



FF0826
ACABAMENTO SUPERIOR
DE CANTO DO FRONTAL LADO
DIREITO SIDER FACCHINI

FF0826A
ACABAMENTO SUPERIOR
DE CANTO DO FRONTAL LADO
ESQUERDO SIDER FACCHINI



FF0803
REFORÇO LATERAL SUPERIOR
LADO DIREITO/ESQUERDO
FACCHINI



FF0828
SUPORTE DESLIZA
FIO SIDER FACCHINI



FF0825
FOLHA DO FRONTAL
SIDER FACCHINI

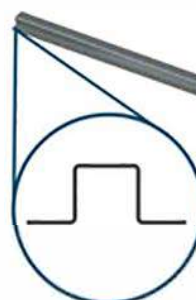

FF0820
COLUNA CENTRAL
DO FRONTAL SIDER
FACCHINI 2800mm



FF0812
COLUNA FRONTAL
LADO DIREITO/
ESQUERDO SIDER
FACCHINI 2960mm

LANÇAMENTOS

COMPATÍVEIS LINHA SIDER

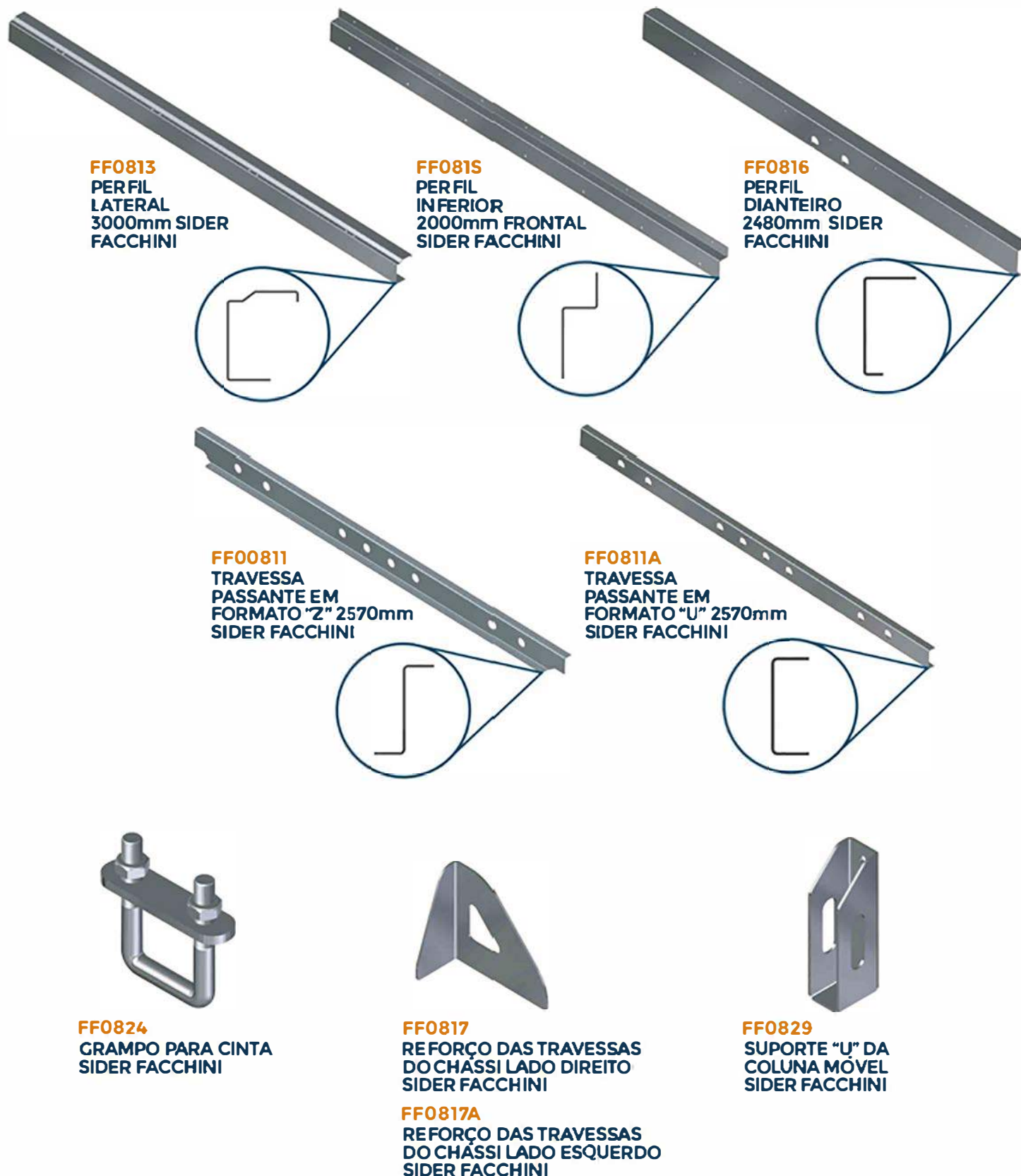

COMPATÍVEL COM LINHA

FACCHINI



LANÇAMENTOS

COMPATÍVEIS LINHA SIDER



FF0818
PERFIL CENTRAL
DO ASSOALHO SIDER
FACCHINI



FF0807
COLUNA TRASEIRA
DO SIDER LADO
DIREITO FACCHINI 2980mm

FF0807A
COLUNA TRASEIRA
DO SIDER LADO
ESQUERDO FACCHINI 2980mm



FF0805
REFORÇO INFERIOR
DO PERFIL TRASEIRO
LADO DIREITO FACCHINI



FF0819
PERFIL TRASEIRO
INFERIOR SIDER
FACCHINI 2470mm



FF0808
SUPORTE DA DOBRADIÇA
DA PORTA TRASEIRA DO
SIDER FACCHINI

FF0805A
REFORÇO INFERIOR
DO PERFIL TRASEIRO
LADO ESQUERDO FACCHINI



FF0802
REFORÇO E CONEXÃO COM
A COLUNA SIDER LADO
DIREITO FACCHINI



FF0821
FIXADOR DO CABO
DE AÇO CENTRAL
SIDER FACCHINI

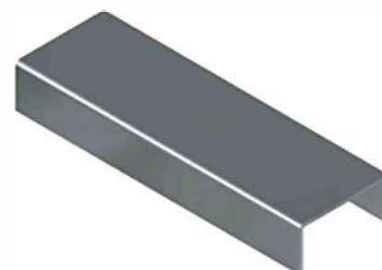

FF0806
REFORÇO SUPERIOR DO
PERFIL TRASEIRO LADO
DIREITO/ESQUERDO
FACCHINI 300mm

FF0802A
REFORÇO E CONEXÃO COM
A COLUNA SIDER LADO
ESQUERDO FACCHINI

LANÇAMENTOS

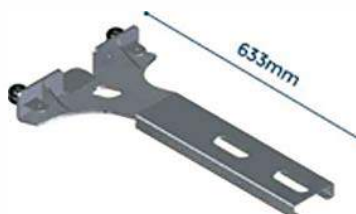
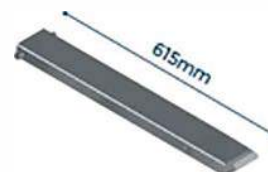
COMPATÍVEIS LINHA SIDER**FF0823**
ARCO 2498mm SIDER FACCHINI**FF0822**
ARCO 2380mm SIDER FACCHINI**FF0809**
SUPOORTE INFERIOR
DE FIXAÇÃO DO ARCO
SIDER FACCHINI**FF0810**
SUPOORTE SUPERIOR
DE FIXAÇÃO DO ARCO
SIDER FACCHINI**FF0800A**
CABEÇA DA
COLUNA MÓVEL
SIDER FACCHINI**FF0800B**
PÉ DE APOIO DA
COLUNA MÓVEL
SIDER FACCHINI**FF0800**
CONJUNTO
COLUNA MÓVEL
SIDER FACCHINI**FF0800C**
COLUNA
SIDER FACCHINI**FF0804**
PERFIL
SUPERIOR
TRASEIRO DO
SIDER FACCHINI
2590mm**FP4088A - PRETO EPÓXI**
FZ4088A - ZINCADA
TRAVESSA SIDER
DOBRADA 3000mm**FP4088 - PRETO EPÓXI**
FZ4088 - ZINCADA
TRAVESSA SIDER
RETA 3000mm

LANÇAMENTOS



LINHA DOLLY

COMPATÍVEL LINHA FACCHINI

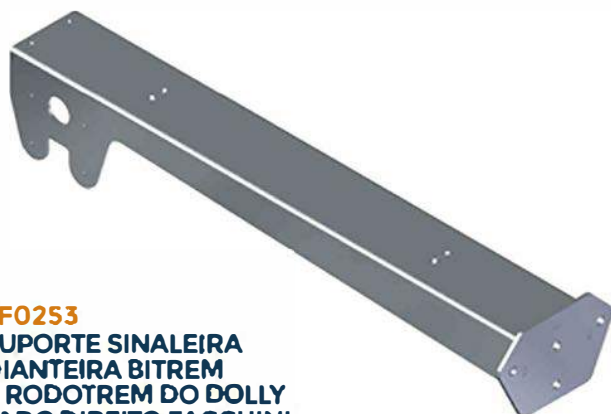

FF0253
SUPORTE SINALEIRA
DIANTEIRA BITREM
E RODOTREM DO DOLLY
LADO DIREITO FACCHINI



FF0253A
SUPORTE SINALEIRA
DIANTEIRA BITREM
E RODOTREM DO DOLLY
LADO ESQUERDO FACCHINI



FF0254
SUPORTE SINALEIRA
TRASEIRA BITREM
E RODOTREM DO DOLLY
LADO DIREITO FACCHINI



FF0254A
SUPORTE SINALEIRA
TRASEIRA BITREM
E RODOTREM DO DOLLY
LADO ESQUERDO FACCHINI



FF0255
SUPORTE SINALEIRA
LATERAL TRASEIRA DO
DOLLY FACCHINI



FF0256
SUPORTE SINALEIRA
DO DOLLY FACCHINI



LANÇAMENTOS

LINHA DOLLY

COMPATÍVEL LINHA RANDON



FR0253
SUPORTE SINALEIRA
TRASEIRA DO DOLLY
COMPLETA RANDON
LADO DIREITO



FR0253A
SUPORTE SINALEIRA
TRASEIRA DO DOLLY
COMPLETA RANDON
LADO ESQUERDO



FR0253B
SUPORTE PARA FIXAÇÃO
DA SINALEIRA DO DOLLY
RANDON LADO DIREITO

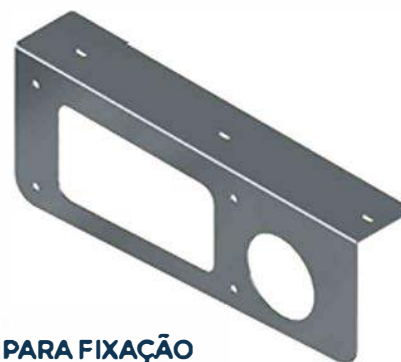

FR0253D
SUPORTE PARA FIXAÇÃO
DA SINALEIRA DO DOLLY
RANDON LADO ESQUERDO



FR0253C
SUPORTE DE FIXAÇÃO
PARA A SINALEIRA DO
DOLLY RANDON



FR0256
SUPORTE SINALEIRA
DIANTEIRA DO DOLLY
LADO DIREITO/
LADO ESQUERDO

LANÇAMENTOS

LINHA DOLLY

COMPATÍVEL LINHA LIBRELATO



FL0253
SUPORTE SINALEIRA
TRASEIRA DO DOLLY
LIBRELATO LADO
DIREITO 2013 A 2018



FL0253A
SUPORTE SINALEIRA
TRASEIRA DO DOLLY
LIBRELATO LADO
ESQUERDO 2013 A 2018

LANÇAMENTOS

LINHA DOLLY

COMPATÍVEL LINHA GUERRA

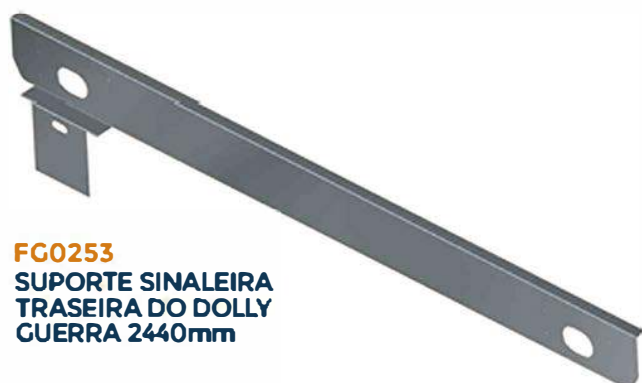

FG0253
SUPORTE SINALEIRA
TRASEIRA DO DOLLY
GUERRA 2440mm

LANÇAMENTOS

LINHA DOLLY

COMPATÍVEL LINHA NOMA



FN0253
SUPORTE SINALEIRA
DO DOLLY LD/LE
NOMA FÊNIX



LINHA TRUCK



F4076A
DOBRADIÇA TRUCK TRASEIRA
LADO DIREITO
F4076B
DOBRADIÇA TRUCK TRASEIRA
LADO ESQUERDO

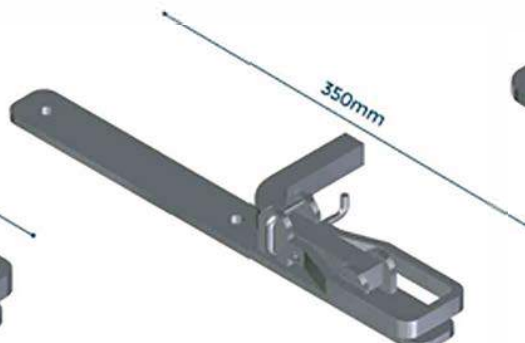

F4076C
DOBRADIÇA TRUCK
DIANTEIRA LADO DIREITO
F4076D
DOBRADIÇA TRUCK
DIANTEIRA LADO ESQUERDO

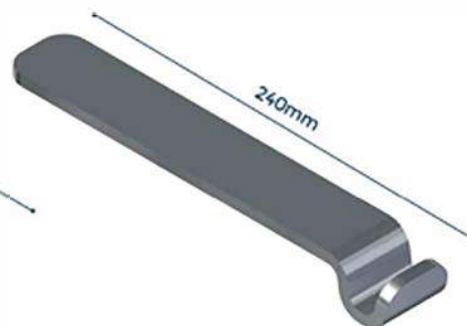

F4076
GANCHO PARA
DOBRADIÇA DO
TRUCK

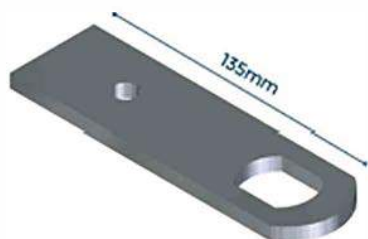

F4026
ENGATE FÊMEA
DACARROÇERIA



FR0011A
ENGATE RÁPIDO
TIPO "C"



F4071
DOBRADIÇA
CURTA 110mm



F4071B
DOBRADIÇA
150mm



F4047
DISPOSITIVOS DE AMARRAÇÃO
PARA TRUCK 50mm

F4047A
DISPOSITIVOS DE AMARRAÇÃO
PARA TRUCK 55mm

F4047B
DISPOSITIVOS DE AMARRAÇÃO
PARA TRUCK 60mm

OBS: A CADA 10 UNIDADES É ENVIADA A PLAQUINHA
DE HOMOLOGAÇÃO.



PRODUTO
HOMOLOGADO



F4036
FIXADOR
PORCA 3/4"

F4036A
FIXADOR
PORCA 5/8"

F4036B
FIXADOR
PORCA 7/8"

BASCULANTES



COMPATÍVEL LINHA RANDON



FR0900
DOBRADIÇA
DA BASCULANTE
RANDON



FR0902
TRAVA TAMPA
DA BASCULANTE
RANDON

COMPATÍVEL LINHA LIBRELATO



FL0903
CATRACA PARA
ESTEPE DA BASCULANTE
LADO DIREITO



FL0902
TRAVA TAMPA
DA BASCULANTE
LIBRELATO



FL0900
DOBRADIÇA
BASCULANTE
LIBRELATO

DIVERSOS



F4114B
DOBRADIÇA
BASCULANTE
MODELO UNIVERSAL



F4114
DOBRADIÇA
BASCULANTE
MODELO UNIVERSAL
"REGULÁVEL"



F4114A
ENGATE
DA DOBRADIÇA
BASCULANTE



F4114E
DOBRADIÇA
LATERAL DA
TAMPA TRASEIRA



F4114F
BRAÇO
ARTICULADO
DO ESTEPE



F4114G
TRANCA
DA TAMPA
BASCULANTE LD

F4114H
TRANCA
DA TAMPA
BASCULANTE LE



LANÇAMENTOS

PARACHOQUES

PARACHOQUES HOMOLOGADOS
Caminhão de 3,5 a 6,5 toneladas



F4170
KIT
PARACHOQUE



F4170F
BATENTE DA
COLUNA FIXA
(CH. 4,75mm)



F4057
REBITE DE
AÇO 1/2" X 1"

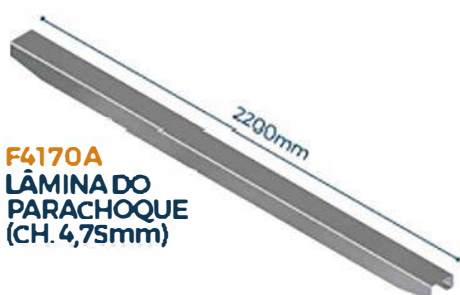

F4170A
LÂMINA DO
PARACHOQUE
(CH. 4,75mm)



F4170C
PINO DE
ARTICULAÇÃO
Ø19,05X120mm



F4170E
REFORÇO DAS
EXTREMIDADES DA
LÂMINA (CH. 4,75mm)



F4170H
MOLA DO
PARACHOQUE

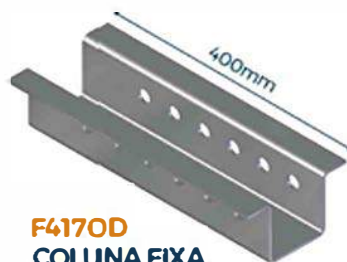

F4170D
COLUNA FIXA
(CH. 4,75mm)



F4170B
COLUNA MÓVEL
(CH. 4,75mm)

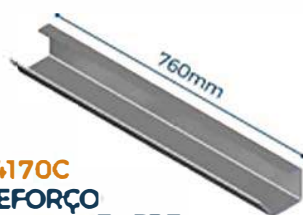

F4170C
REFORÇO
INTERNO ENTRE
COLUNAS (CH. 4,75mm)



PERFIL
ANTIDERRAPANTE
ALUMÍNIO
F4072 - 2200mm
F4073 - 2400mm

LANÇAMENTOS

PARACHOQUES

PARACHOQUES HOMOLOGADOS
Caminhão de 6,5 a 10 toneladas



F4171
KIT
PARACHOQUE



F4170F
BATENTE DA
COLUNA FIXA
(CH. 4,75mm)



F4057
REBITE DE
AÇO 1/2" X 1"

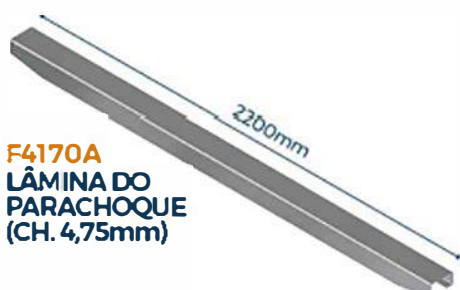

F4170A
LÂMINA DO
PARACHOQUE
(CH. 4,75mm)



F4170C
PINO DE
ARTICULAÇÃO
Ø19,05 X 120mm

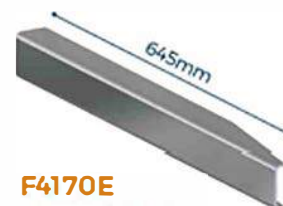

F4170E
REFORÇODAS
EXTREMIDADES DA
LÂMINA (CH. 4,75mm)



F4170H
MOLA DO
PARACHOQUE

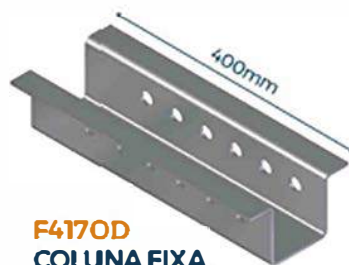

F4170D
COLUNA FIXA
(CH. 4,75mm)

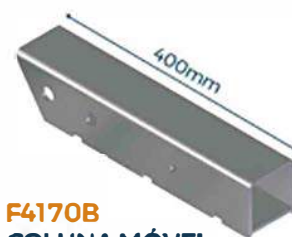

F4170B
COLUNA MÓVEL
(CH. 4,75mm)

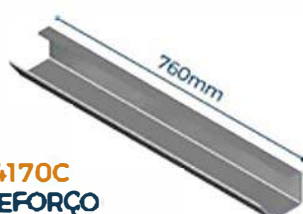

F4170C
REFORÇO
INTERNO ENTRE
COLUNAS (CH. 4,75mm)



PERFIL
ANTIDERRAPANTE
ALUMÍNIO
F4072 - 2200mm
F4073 - 2400mm



LANÇAMENTOS

PARA CHOQUES

PARA CHOQUES HOMOLOGADOS
Caminhão de 10 a 23,5 toneladas



F4172
KIT
PARA CHOQUE



F4172F
BATE NTE DA
COLUNA FIXA
(CH. 6,35mm)



F4057
REBITE DE
AÇO 1/2" X 1"



F4172A
LÂMINA DO
PARA CHOQUE
(CH. 6,35mm)



F4172G
PINO DE
ARTICULAÇÃO
Ø25,40 X 135mm



F4172E
REFORÇO DAS
EXTREMIDADES DA
LÂMINA (CH. 4,75mm)



F4170H
MOLA DO
PARA CHOQUE



F4172D
COLUNA FIXA
(CH. 6,35mm)



F4172B
COLUNA MÓVEL
(CH. 4,75mm)

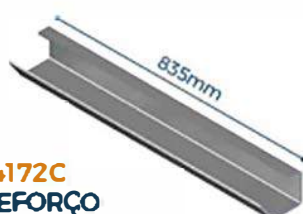

F4172C
REFORÇO
INTERNO ENTRE
COLUNAS (CH. 4,75mm)



PERFIL
ANTIDERRAPANTE
ALUMÍNIO
F4072 - 2200mm
F4073 - 2400mm

LANÇAMENTOS

PARACHOQUES

PARACHOQUES HOMOLOGADOS
Caminhão acima de **23,5 toneladas**



F4173
KIT
PARACHOQUE



F4173F
BATE NTE DA
COLUNA FIXA
(CH. 6,35mm)



F4057
REBITE DE
AÇO 1/2" X 1"



F4173A
LÂMINA DO
PARACHOQUE
(CH. 7,94mm)



F4173G
PINO DE
ARTICULAÇÃO
Ø25,40 X 160mm

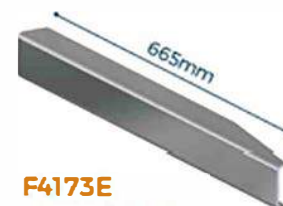

F4173E
REFORÇO DAS
EXTREMIDADES DA
LÂMINA (CH. 4,75mm)



F4170H
MOLA DO
PARACHOQUE



F4173D
COLUNA FIXA
(CH. 6,35mm)



F4173B
COLUNA MÓVEL
(CH. 6,35mm)

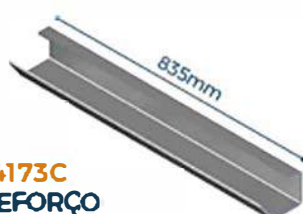

F4173C
REFORÇO
INTERNO ENTRE
COLUNAS (CH. 4,75mm)



PERFIL
ANTIDERRAPANTE
ALUMÍNIO
F4072 - 2200mm
F4073 - 2400mm



super lançamentos

CAIXA DE FERRAMENTAS

PREMIUM

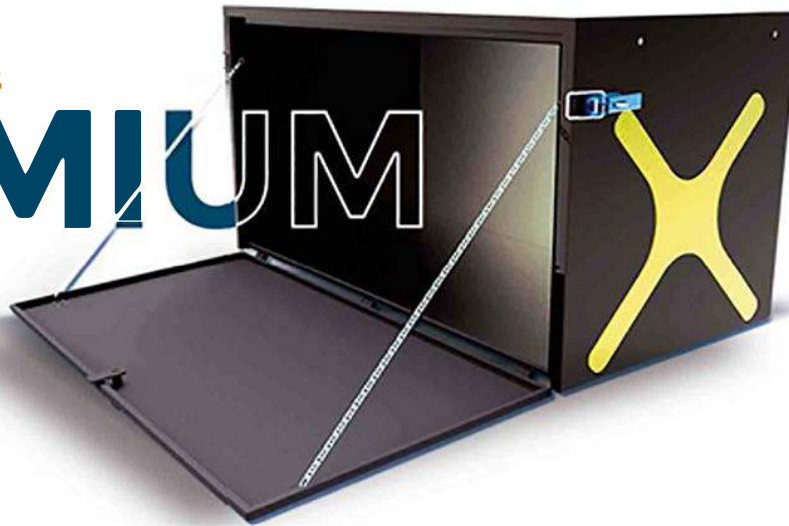

FECHADURA PADRÃO



cód.	A	X	C	X	P
F4043	500	X	500	X	500mm
F4100	600	X	600	X	600mm
F4102	600	X	535	X	600mm
F4123	500	X	600	X	600mm
F4103	600	X	1000	X	600mm
F4101	600	X	1140	X	600mm
F4113	600	X	900	X	600mm

FECHADURA PLÁSTICA



cód.	A	X	C	X	P
F4043A	500	X	500	X	500mm
F4108	600	X	600	X	600mm
F4109	600	X	535	X	600mm
F4123A	500	X	600	X	600mm
F4110	600	X	1000	X	600mm
F4111	600	X	1140	X	600mm
F4113A	600	X	900	X	600mm

FECHADURA INOX



cód.	A	X	C	X	P
F4043B	500	X	500	X	500mm
F4108A	600	X	600	X	600mm
F4109A	600	X	535	X	600mm
F4123B	500	X	600	X	600mm
F4110A	600	X	1000	X	600mm
F4111A	600	X	1140	X	600mm
F4113B	600	X	900	X	600mm

FECHADURA METAL COR PRETA



cód.	A	X	C	X	P
F4043C	500	X	500	X	500mm
F4108B	600	X	600	X	600mm
F4109B	600	X	535	X	600mm
F4123C	500	X	600	X	600mm
F4110B	600	X	1000	X	600mm
F4111B	600	X	1140	X	600mm
F4113C	600	X	900	X	600mm



F4112
Caixa de Ferramenta
300 X 500 X 500mm
Furgão - Sem Estampo



F4100A
Trava Lateral
Caixa de Ferramenta



F4100B
Trava Central
Caixa de Ferramenta



F4082
Suporte Reto
Caixa de Ferramenta



F4082A
Suporte "Z" 50mm
Caixa de Ferramenta

F4082B
Suporte "Z" 95mm
Caixa de Ferramenta



F4082C
Suporte p/ Caixa
de Cozinha LD/LE
(conjunto 2 peças)

A Fado desenvolve Caixas de Ferramentas conforme a sua necessidade.
(consulte o representante da sua região ou fábrica)

LANÇAMENTOS

RESERVATÓRIOS DE AR



F4090
RESERVATÓRIO DE AR
117 LITROS COM SAÍDA "ABS"



F4090A
RESERVATÓRIO DE AR
117 LITROS COM SAÍDA
"ABS" FIXAÇÃO/CINTA



F4090B
RESERVATÓRIO DE AR
73 LITROS COM SAÍDA "ABS"

* Cor meramente ilustrativa.

LANÇAMENTOS

SUPORTE DE ESTEPE

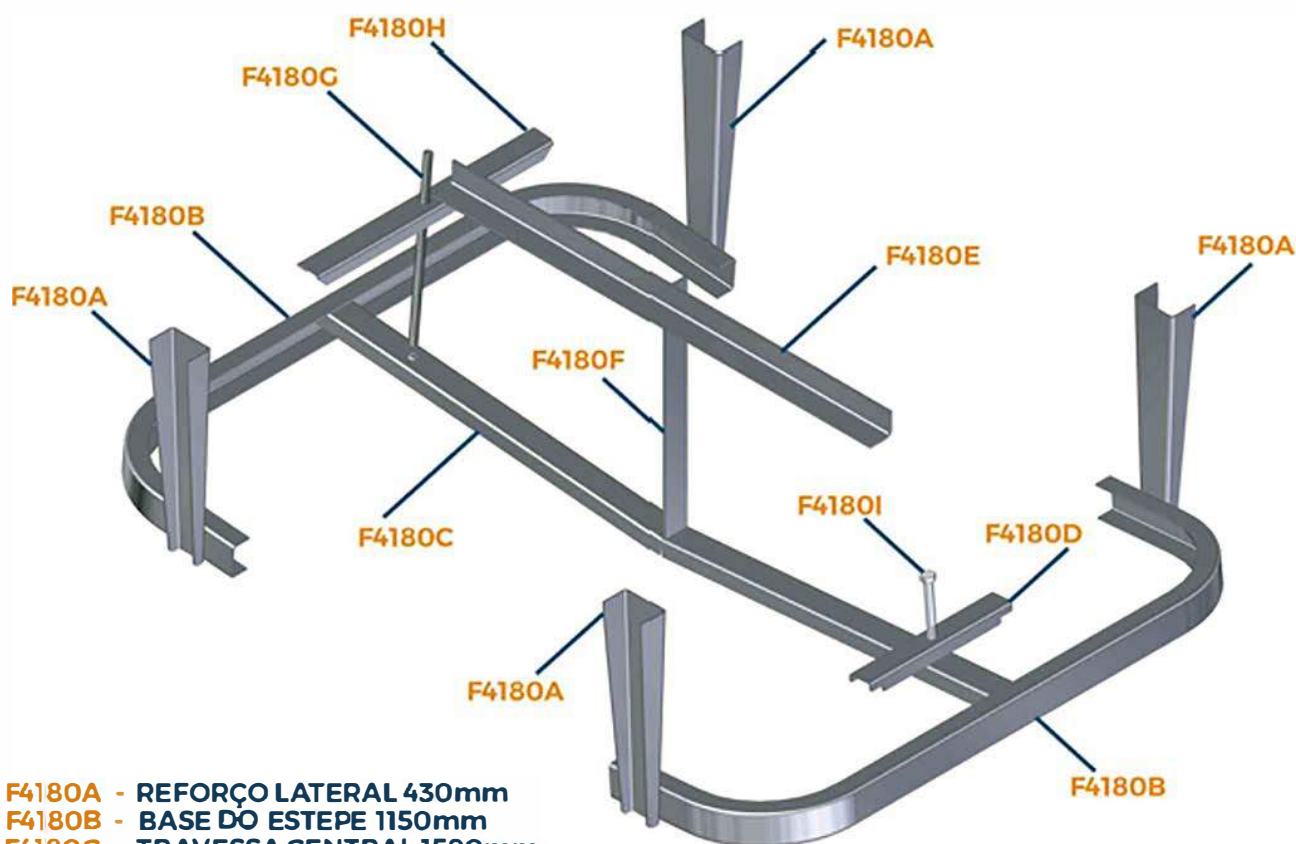

- F4180A - REFORÇO LATERAL 430mm
- F4180B - BASE DO ESTEPE 1150mm
- F4180C - TRAVESSA CENTRAL 1590mm
- F4180D - SUP. FIXAÇÃO DA RODA DISCO 325mm
- F4180E - REFORÇO HORIZONTAL CENTRAL 1000mm
- F4180F - REFORÇO VERTICAL CENTRAL 495mm
- F4180G - PARAFUSO M16 X 400mm
- F4180H - SUP. FIXAÇÃO DA RODA RAIADA 540mm
- F4180I - PARAFUSO M16 X 130mm

* Imagem ilustrativa da montagem.
As peças são vendidas avulsas e a montagem é realizada pelo cliente.



F4001
SUPORTE PARALAMA
CARRETA RANDON LEVE

F4001A
SUPORTE PARALAMA
CARRETA RANDON
REFORÇADO



F4000
SUPORTE PARALAMA
CARRETA RANDON
MODELO 2020



F4002
SUPORTE PARALAMA
CARRETA UNIVERSAL
(5 FUROS) LEVE

F4002A
SUPORTE PARALAMA
CARRETA UNIVERSAL
(5 FUROS) REFORÇADO



F4007
SUPORTE PARALAMA
CARRETA FACCHINI



F4008
SUPORTE PARALAMA
CARRETA LIBRELATO



F4010
SUPORTE PARALAMA
CARRETA GUERRA



F4009
SUPORTE PARALAMA
CARRETA NOMA



F4012
SUPORTE PARALAMA CARRETA
NOMA TITANIUM LEVE

F4012A
SUPORTE PARALAMA CARRETA
NOMA TITANIUM REFORÇADO



F4017
SUPORTE PARALAMA
BASCULANTE NOMA
TITANIUM LEVE

F4017A
SUPORTE PARALAMA
BASCULANTE NOMA
TITANIUM REFORÇADO



F6453
SUPORTE PARALAMA
CAMINHÃO 3/4

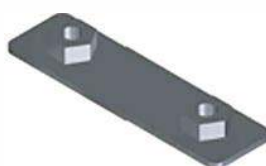

F4005
CHAPA DA ABRAÇADEIRA
SUPORTE PARALAMA



F4004
ABRAÇADEIRA PARA
SUPORTE DO PARALAMA

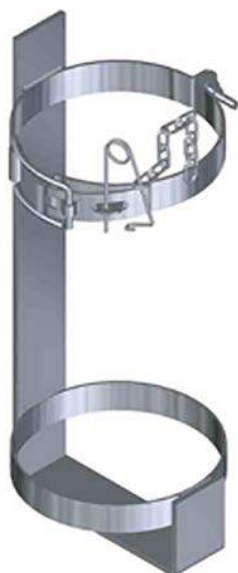

F4013
SUPORTE PARA
EXTINTOR 12kg

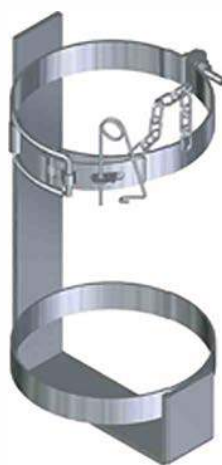

F4014
SUPORTE PARA
EXTINTOR 8 E 10kg



F4042
SUPORTE PARA
BOTIJÃO P13



F4096
SUPORTE PARA
BOTIJÃO P5



F4097
SUPORTE PARA
BOTIJÃO P8



F4018
ANEL ESPAÇADOR RODA
ARO 22 COM 12 FUROS



F4021
ANEL ESPAÇADOR RODA
ARO 20 COM 12 FUROS



F4022
ANEL ESPAÇADOR RODA
ARO 20 COM 10 FUROS



F4015
CATRACA PARA
CABO DE AÇO



F4089
CATRACA SIDER
100% ZINCADA
EIXO TRAÇÃO INTEIRO



F4089E
CONJUNTO
DE FIXAÇÃO
CATRACÃO SIDER
ACOMPANHA PARAFUSO



F4016
CATRACA PARA
CINTA



F4085
DISPOSITIVO DE
AMARRAÇÃO INTERNA



F4087
GRAMPO PARA
BOBINEIRA



F4091
ESCADA RETRÁTIL
TRASEIRA 3 DEGRAUS



F4084
SUPORTE PARA
TAMPA DO TOMBADOR

diversos



F4061
TIRAFINO TRITUBULAR
ALUMÍNIO 2100mm

F4062
TIRAFINO TRITUBULAR
ALUMÍNIO 2300mm

F4063
TIRAFINO TRITUBULAR
ALUMÍNIO 2430mm

F4064
TIRAFINO TRITUBULAR
ALUMÍNIO 2970mm



F4065
PONTEIRA TIRAFINO
TRITUBULAR (PLÁSTICA)



F4092A
PONTEIRA PLÁSTICA
CURVADA 500mm



F4093A
PONTEIRA PLÁSTICA
30x100mm



PERFIL DE ALUMÍNIO
F4094 - 30x100x2000mm
F4094A - 30x100x3000mm
F4094B - 30x100x6000mm



F4092
PONTEIRA DE
ALUMÍNIO
CURVADA 500mm



F4093
PONTEIRA DE
ALUMÍNIO RETA
500mm



F4086
PROTECTOR LATERAL
MÓVEL (COMPLETO)



F4086A
PROTECTOR
LATERAL MÓVEL
(S/ COMPONENTES)
DE FIXAÇÃO





F4034
PINO DE TAMPA COM
CORRENTE Ø 6mm

F4034A
PINO DE TAMPA COM
CORRENTE Ø 7mm

F4034B
PINO DE TAMPA COM
CORRENTE Ø 8mm



F4034C
PINO DE TAMPA COM
CORRENTE Ø 6mm
PONTA DOBRADA

F4034D
PINO DE TAMPA COM
CORRENTE Ø 7mm
PONTA DOBRADA



F4048C
PINO TAMPA Ø 6mm
PONTA DOBRADA

F4048D
PINO TAMPA Ø 7mm
PONTA DOBRADA



F4048
PINO DE TAMPA Ø 6mm

F4048A
PINO DE TAMPA Ø 7mm

F4048B
PINO DE TAMPA Ø 8mm



F4049
CORRENTINHA PINO
TAMPA 170mm



F4049A
CORDA PLÁSTICA
PINO TAMPA



F4035C
PINO QUEBRA DEDO
Ø 6mm C/ PLÁSTICO

F4035D
PINO QUEBRA DEDO
Ø 8mm C/ PLÁSTICO



F4035E
PINO QUEBRA DEDO
Ø 6mm C/ CABO DE AÇO

F4035F
PINO QUEBRA DEDO
Ø 8mm C/ CABO DE AÇO



F4035G
PINO QUEBRA DEDO
Ø 6mm C/ CORRENTE

F4035H
PINO QUEBRA DEDO
Ø 8mm C/ CORRENTE



F4035
QUEBRA DEDO Ø 6mm

F4035A
QUEBRA DEDO Ø 8mm



F4054
JOANINHA



F4059
GRAMPO "R" TRAVA
TOMBADOR

diversos



F4045
CONJUNTO CORRENTE
COMPLETO



F4046
CONJUNTO
ENGATES
CORRENTE



F4056
"S" DO ENGATE
DA CORRENTE



F4055
ARGOLA ENGATE
CORRENTE



F4037
CORRENTE 1,33mm



F4011
ENGATE PARA CORRENTE
DA TAMPA LATERAL



F4041
ENGATE CORRENTE
MODERNO



F4053
PRESILHA DO
FUEIRO



F4028
PRESILHA "V"
DA TAMPA (40mm
INTERNA)



F4028A
PRESILHA "V"
DA TAMPA (32mm
INTERNA)



F4027
PRESILHA "U"
DA TAMPA (30mm
INTERNA)



F4027A
PRESILHA "W"
DA TAMPA (40mm
INTERNA)

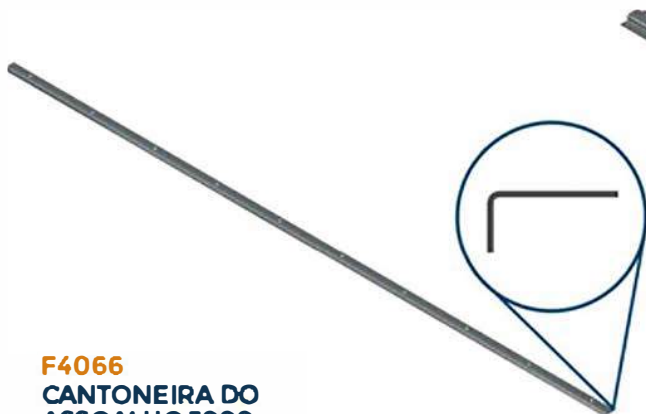

F4066
CANTONEIRA DO
ASSOALHO 3000mm



F4067
PERFIL UNIÃO P/
ASSOALHO 18mm

F4067A
PERFIL UNIÃO P/
ASSOALHO 20mm

F4067B
PERFIL UNIÃO P/
ASSOALHO 22mm

F4067C
PERFIL UNIÃO P/
ASSOALHO 25mm



F4044
SUPORTE LONA P/
GRANELEIRA (SEM FOMINHA)



FR0024A
GUIA DA FOMINHA



F4057
REBITE DE AÇO
1/2" X 1"



FR0049
SUPORTE DO ARCO



FR0050
ENGATE DA CINTA



F4050
ARCO DE LONA
(NA VIGUETA)
2525mm

F4051
ARCO DE LONA
(NO SUPORTE)
2380mm

F4052
ARCO DE LONA
(NOMA)
2580mm

F4095
ARCO CAÇAMBA
BASCULANTE
2420mm



F4098
ARCO DE LONA
FACCHINI
2500mm



diversos



F4019
SUPORTE LANTERNA
LATERAL



F4020
SUPORTE LANTERNA
LATERAL



F4068
SUPORTE LANTERNA
LATERAL (PLÁSTICA)



F4060
CALÇO TIRA FINO
(PLÁSTICA)

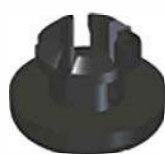

F4070
TAMPA P/ FURO
Ø 8mm (PLÁSTICA)



F4065
PONTEIRA TIRA FINO
TRIANGULAR
(PLÁSTICA)



F4074
CORDA ELÁSTICA
PRESILHA METAL



F4075
CORDA ELÁSTICA
PRESILHA PLÁSTICA



F4202
BOCA DE GRANELEIRA
UNIVERSAL (NYLON)



F4201A
BOCA DE GRANELEIRA
RANDON MODERNA
S/ REBAIXE (NYLON)



F4201
BOCA DE GRANELEIRA
RANDON (NYLON)



F4203
BOCA DE GRANELEIRA
GUERRA (NYLON)

LANÇAMENTOS

PATIM DE FREIO Carreta/Truck



F4151
Patim de Freio 8" s/ rolete (LD/LE)

APLICAÇÃO	Master Carreta - (89/.) - 8" Eixo T
Nº ORIGINAL	A3222K1831
Lona Fras-le	CA-32
Lona Flex	L-638
Lona Duroline	DC332
Lona Thermoid	TH-4516



F4150
Patim de Freio 8" s/ rolete (LD/LE)

APLICAÇÃO	Carreta Q-plus Guerra (95/.) Randon (99/.) 8" 25700037 Eixo T
Nº ORIGINAL	A3222M461
Lona Fras-le	CA-33
Lona Flex	L-636
Lona Duroline	DC333
Lona Thermoid	TH-204



F4152
Patim de Freio 8,5" s/ rolete (LD/LE)

APLICAÇÃO	Carreta Guerra 8,5" (95/.) Eixo T
Nº ORIGINAL	1270 280156
Lona Fras-le	FD/81
Lona Flex	L-637
Lona Duroline	DC381
Lona Thermoid	TH-187



F4155
Pino do Patim 6" 7" 8"
31,8 X 59mm (19mm)

APLICAÇÃO	Carreta 6" 7" 8" 31,8 X 59mm Bendix/Master
Nº ORIGINAL	TE 3.607.043



F4154
Rolete do Patim 6" 7" 8"
31,8 X 57mm (22mm)

APLICAÇÃO	Carreta 6" 7" 8" 31,8 X 57mm Bendix/Master
Nº ORIGINAL	TE 3.607.057



F4156
Rolete do Patim 6" 7" 8"
38 X 57,5mm (25mm)

APLICAÇÃO	Carreta 6" 7" 8" 38 X 57,5mm Bendix/Master
Nº ORIGINAL	3814200330



F4157
Rolete da Sapata 6" 7" 8"
35 X 57,5mm

APLICAÇÃO	Carreta 6" 7" 8" 35 X 57,5mm Bendix/Master
Nº ORIGINAL	3854231674



F4158
Pino do Patim 6" 7" 8"
28,5 X 58mm

APLICAÇÃO	Carreta 6" 7" 8" 28,5 X 58mm Bendix Moderno (90/.)
Nº ORIGINAL	XXXXXXXXXX

LANÇAMENTOS

PATIM DE FREIO Compatível Linha Volvo



F4153
Patim de Freio Traseiro A ArT s/rolete

APLICAÇÃO	Caminhão Volvo Vm 77, 23 e 43 t Caminhão Volvo Vm 23 @2 Eixo T 3°
Nº ORIGINAL	AS222F212
Lona Fras-le	VV/306
Lona Flex	
Lona Duroline	
Lona Thermoid	



F4159
Patim de Freio Primária Dianteira

APLICAÇÃO	Volvo Nh 12 (99/...) / Fh 12 Global roller (98/...) Eixo D
Nº ORIGINAL	3.095.195 / 6837324
Lona Fras-le	VV-303
Lona Flex	
Lona Duroline	
Lona Thermoid	



F4160
Patim de Freio Secundária Dianteira

APLICAÇÃO	Volvo Nh 12 (99/...) Fh 12 Global roller (98/...) / Fm 12 Eixo D
Nº ORIGINAL	3.095.195 / 68371525
Lona Fras-le	VV/303
Lona Flex	
Lona Duroline	
Lona Thermoid	



F4161
Patim de Freio Primária Traseira

APLICAÇÃO	Volvo Nh 12 (99/...) / Fh 12 Global roller (98/...) / Fm 12 Eixo T
Nº ORIGINAL	3.095.196 / 68371526
Lona Fras-le	VV-304
Lona Flex	
Lona Duroline	
Lona Thermoid	



F4162
Patim de Freio Secundária Traseira

APLICAÇÃO	Volvo Nh 12 (99/...) Fh 12 Global roller (98/...) / Fm 12 Eixo T
Nº ORIGINAL	3.095.196 / 68371527
Lona Fras-le	VV/304
Lona Flex	
Lona Duroline	
Lona Thermoid	



F4163
CHAPA JUMELO
MOLA 2 FUROS

APLICAÇÃO	Volvo B58
Nº ORIGINAL	1134553



F4164
CHAPA JUMELO
MOLA 3 FUROS

APLICAÇÃO	Volvo B58
Nº ORIGINAL	1134552

LANÇAMENTOS

PATIM DE FREIO

Compatível Linha Volkswagen



F4165

Patim de Freio Traseiro A Ar 7" s/rolete

APLICAÇÃO	7" Vw - Caminhões 14.250/14.770 81/14.200/14.220/14.770 81/16.200/16.200 (L/S) - 16.300 22.200/16.300/24.220/14.250/35.300/35.500 Cl (L) Ônibus 16180 Co (L) - 16.270 Cd (L)
Nº ORIGINAL	T12.607.525
Lona Fras-le	FD-88
Lona Flex	L-224
Lona Durolino	DFW988
Lona Thermoid	TH-166



F4166

Patim de Freio Traseiro A Ar 6" Ma (15" X 6") s/rolete

APLICAÇÃO	Volkswagen Freios A Ar 11140/12340 Ônibus - Dianteiro / 180c Sizzema Master 1370 B1/16.200/16.220/16.300/22240/24.250/35.300/35.300 Cl
Nº ORIGINAL	A3222E2111
Lona Fras-le	FD-87
Lona Flex	L-223
Lona Durolino	DFW987
Lona Thermoid	TH-165

CONHEÇA A FADO

Leia o QR Code e assista o vídeo institucional no  YouTube



FAÇA O SEU ORÇAMENTO:

 (54) 3291.1507  (54) 99200.5195  pedido@fado.com.br  www.fado.com.br

VRS 315 Km 3,9 n° 718 São Marcos/RS Cep 95190-000

  fadoautopecas  fadoautopecas